

KENWOOD

ALLMODE TRIBANDER

TS-790A
TS-790E

INSTRUCTION MANUAL

KENWOOD CORPORATION

Downloaded by
Amateur Radio Directory

www.hamdirectory.info

Thank you for purchasing this new transceiver.

IMPORTANT:

Please read this Instruction Manual carefully before placing the transceiver in service.

SAVE THIS INSTRUCTION MANUAL.

The following explicit definitions apply in this manual:

Note : If disregarded, inconvenience only, no risk of equipment damage or personal injury.

Caution : Equipment damage may occur, but not personal injury.

This Instruction Manual covers the following models:

TS-790A: All Mode Tribander
(U.S.A. and general markets)

TS-790E: All Mode Tribander
(U.K. and European markets)

Illustrations show the TS-790A.

CONTENTS

1. BEFORE OPERATION	3	5. BLOCK DIAGRAM AND CIRCUIT DIAGRAM ..	49
2. SPECIFICATIONS AND ACCESSORIES	4	5-1. BLOCK DIAGRAM.....	49
2-1. SPECIFICATIONS	4	5-2. CIRCUIT DIAGRAM.....	51
2-2. ACCESSORIES	5	6. MAINTENANCE AND ADJUSTMENTS	63
3. INSTALLATION AND CONNECTION	6	6-1. GENERAL INFORMATION	63
3-1. INSTALLATION	6	6-2. SERVICE	63
3-2. CONNECTION	6	6-3. CLEANING	63
4. OPERATION	8	6-4. IN CASE OF DIFFICULTY.....	64
4-1. OPERATING CONTROLS	8	6-5. ORDERING SPARE PARTS	65
4-2. RECEIVER OPERATION.....	26	6-6. ADJUSTMENTS	65
4-3. TRANSMITTER OPERATION.....	32	7. OPTIONAL ACCESSORIES	66
4-4. MEMORY.....	34	7-1. VS-2 VOICE SYNTHESIZER	
4-5. SCAN	41	INSTALLATION	66
4-6. REPEATER OPERATION.....	43	7-2. TSU-5 PROGRAMMABLE TONE	
4-7. TONE SQUELCH (CTCSS).....	44	DECODER UNIT INSTALLATION.....	66
4-8. TRACE FUNCTION.....	44	7-3. UT-10 1200MHz UNIT INSTALLATION ..	67
4-9. SATELLITE COMMUNICATIONS	45	7-4. OTHER ACCESSORIES	69
4-10. DATA COMMUNICATIONS	46	8. REFERENCE	70
4-11. OPERATION WITH A PERSONAL			
COMPUTER	47		
4-12. VOICE SYNTHESIZER	48		
4-13. 1200MHz IF CONNECTOR AND ACC4			
CONNECTOR	48		

1. **WARNING** BEFORE OPERATION

TO PREVENT ELECTRIC SHOCK, FIRE AND OTHER INJURY. PLEASE NOTE THE FOLLOWINGS:

Do not place this unit, where it will be exposed to direct sunlight or close to heating appliances.

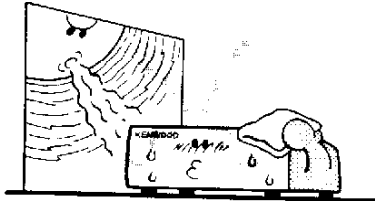

Do not drop pieces of metal, needles, coins and other electrically conductive materials into the unit.

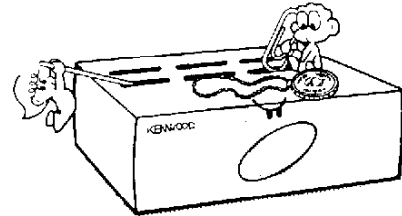

Do not place anything on top of the cabinet.

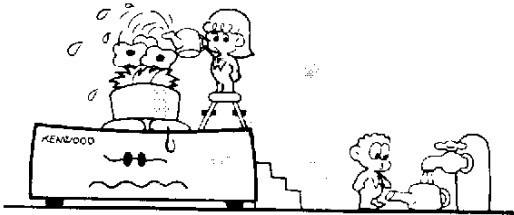

Do not touch the power plug, when your hands are wet.



To ensure good ventilation, do not put anything on top of the cabinet and allow at least 15 cm (6 inches) of space behind the unit.

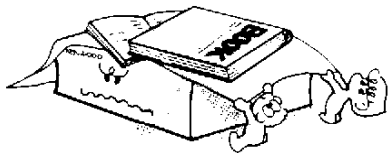

Do not pull the power cord, when disconnecting it from the AC wall outlet. Grasp the plug and ensure that your fingers do not touch the live pins.



Do not place the unit in areas of excessive dust, high humidity or on unstable surfaces.

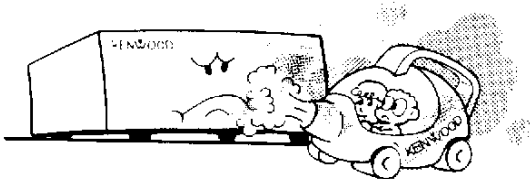

If an abnormal odor or smoke is detected, immediately turn the power off and pull out the power plug. Contact the KENWOOD service station or your dealer.

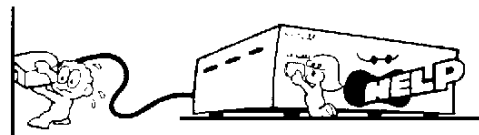

To avoid risk of electric shock, under no circumstances should the unit be opened:

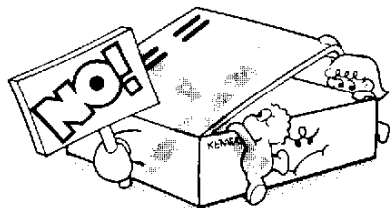

CLEANING

1. Turn the power off, before cleaning the unit.
2. Do not use any type of abrasive pad, thinner, benzene or any substances which may damage the unit.
3. Wipe the front panel and other exterior surfaces of the unit with a soft dry cloth or a soft cloth lightly moistened with water.

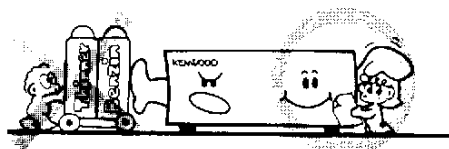

2. SPECIFICATIONS AND ACCESSORIES

Downloaded by
Amateur Radio Directory
www.hamdirectory.info

2-1. SPECIFICATIONS

Specifications		Model	TS-790A	TS-790E		
General	Frequency range	2 m band	144 ~ 148 MHz	144 ~ 146 MHz		
		70 cm band	430 ~ 450 MHz*1	430 ~ 440 MHz		
		23 cm band	1240 ~ 1300 MHz (Option)			
	Mode	J3E (LSB, USB), A1A (CW), F3E (FM)				
	Antenna impedance	50 ohms				
	Power requirement	13.8 VDC ± 15%				
	Grounding	Negative				
	Current drain	Receive mode with no input signal		2.5 A		
		Transmit mode	2 m band	12 A		
			70 cm band	15 A		
	23 cm band		8 A			
	Operating temperature	- 10 to +50°C (+14 to +122°F)				
	Frequency stability (Except FM mode)	Less than ±3 PPM				
	Dimensions (W×H×D) (Projections included)	342×134×369 mm (13-15/32"×5-9/32"×14-17/32")				
Weight	9.2 kg (20.2 lbs)					
Transmitter	Output power	2 m band	LSB·USB	35 W		
			FM·CW	45 W		
		70 cm band	LSB·USB	30 W		
			FM·CW	40 W		
		23 cm band	LSB, USB, CW, FM		10 W	
			Modulation	LSB, USB	Balanced modulation	
		FM	Reactance modulation			
	Spurious radiation	2 m/70 cm band		Less than -60 dB		
		23 cm band		Less than -50 dB		
	Carrier suppression	More than 40 dB (with 1.5 kHz reference)				
Unwanted sideband suppression	More than 40 dB (with 1.5 kHz reference)					
Maximum frequency deviation (FM)	±5 kHz					
Frequency response (-6 dB) (SSB mode only)	400 to 2600 Hz					
Microphone impedance	600 ohms					
Circuitry	2 m band	LSB·USB·CW	Single conversion superheterodyne			
		FM	Double conversion superheterodyne			
	70 cm band	LSB·USB·CW	Double conversion superheterodyne			
		FM	Triple conversion superheterodyne			
	23 cm band	LSB·USB·CW	Triple conversion superheterodyne			
		FM	Quadruple conversion superheterodyne			
Receiver	Intermediate frequency	MAIN				
			1st IF	2nd IF	3rd IF	4th IF
		2 m band	10.695 MHz	* 455 kHz	-	-
		70 cm band	75.925 MHz	10.695 MHz	* 455 kHz	-
		23 cm band	287.175 MHz	41.415 MHz	10.695 MHz	* 455 kHz
		SUB RX				
			1st IF	2nd IF	3rd IF	4th IF
		2 m band	10.595 MHz	* 455 kHz	-	-
		70 cm band	75.925 MHz	10.595 MHz	* 455 kHz	-
		23 cm band	287.075 MHz	41.315 MHz	10.595 MHz	* 455 kHz

* : FM only

Receiver	Sensitivity	LSB, USB, CW (at 10 dB S+N/N)	2 m band	Less than 0.16 μ V
			70 cm band	Less than 0.16 μ V
			23 cm band	Less than 0.16 μ V
		FM (at 12 dB SINAD)	2 m band	Less than 0.22 μ V
			70 cm band	Less than 0.22 μ V
			23 cm band	Less than 0.22 μ V
	Selectivity	LSB, USB		-6 dB: 2.1 kHz, -60 dB: 4.8 kHz
		FM		-6 dB: 12 kHz, -60 dB: 24 kHz
		CW		-6 dB: 500 Hz, -50 dB: 2 kHz
	Image ratio	2 m band		More than 65 dB
		70 cm band		More than 60 dB
		23 cm band		More than 55 dB
	IF SHIFT variable range			More than \pm 0.9 kHz
	RIT variable range	LSB, USB, CW		\pm 1.9 kHz
		FM		\pm 9.9 kHz
Squelch sensitivity	LSB, USB, CW		Less than 0.20 μ V	
	FM		Less than 0.16 μ V	
Output			1.5 W across 8 ohms load (10% distortion)	
Output load impedance			8 ohms	

Notes:

- *1: Frequency range for M2 type is 430 ~ 440 MHz.
- Circuit and ratings are subject to change without notice due to advancements in technology.

2-2. ACCESSORIES

Unpack your TS-790A/790E carefully and confirm that it is supplied with the following accessories.

Dynamic microphone	T91-0352-15.....	1 ea.
DIN plug (7-pin)	E07-0751-05.....	1 ea.
DIN plug (13-pin)	E07-1351-05.....	1 ea.
DC power cable assembly	E30-2065-05.....	1 ea.
Fuse (15A)	F05-1531-05.....	1 ea.
Connector cable for the Tone unit (Except U.K. and Europe version) ...	E31-3453-05.....	1 ea.
Control location sticker	B42-3314-04.....	1 ea.
External control Instruction Manual	B50-8262-XX.....	1 copy
Instruction Manual	B50-8254-XX.....	1 copy
Warranty card (U.S.A. and Europe version only)		1 ea.

After unpacking

Shipping container:

Save the boxes and packing in the event your unit needs to be transported for remote operation, maintenance, or service.

Downloaded by
 Amateur Radio Directory

www.hamdirectory.info

3. INSTALLATION AND CONNECTION

3-1. INSTALLATION

■ FRONT FEET

By extending the front feet, the front panel can be elevated for operating convenience. Turn the front feet left and pull down. Then turn right to lock.

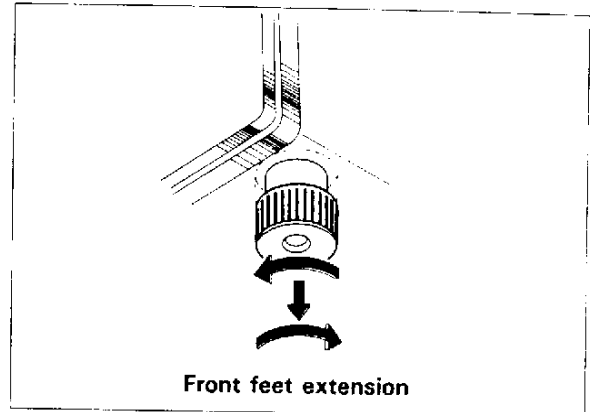

3-2. CONNECTION

The TS-790A/790E requires more than 15A at 13.8 VDC when transmitting at full power. Use the PS-31 power supply for fixed station operation.

A. Rear Panel

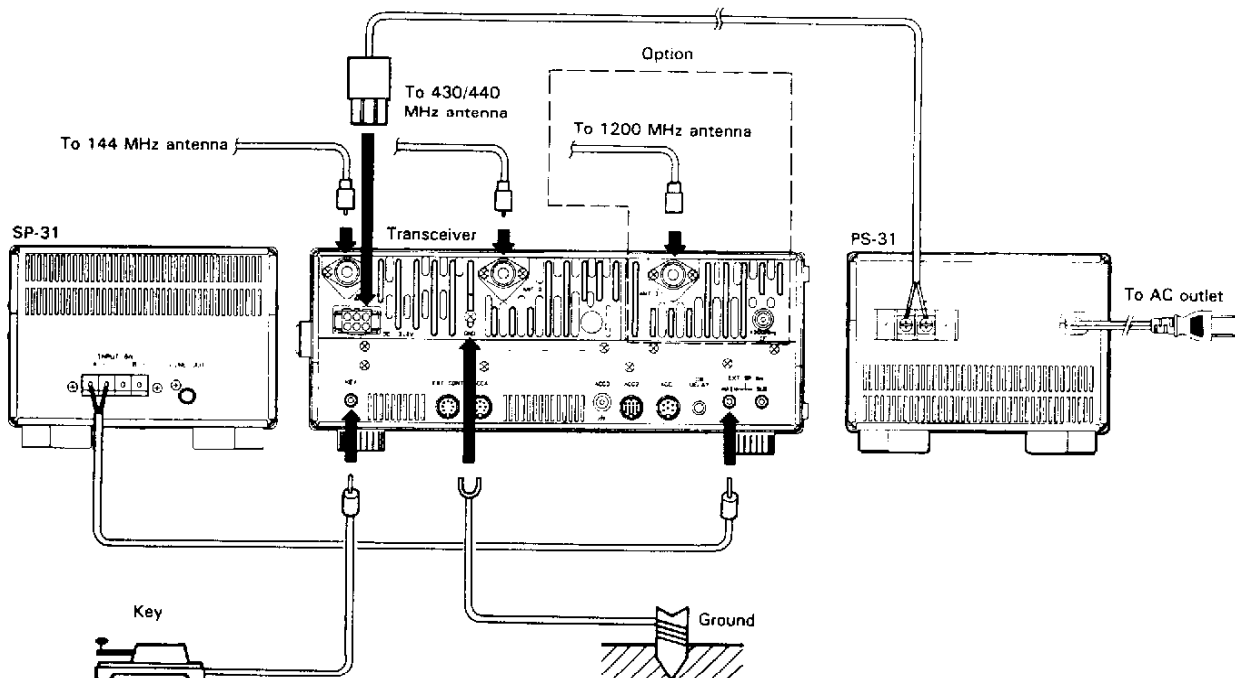

4. OPERATION

4-1. OPERATING CONTROLS

4-1-1. Front Panel

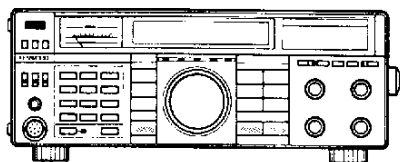

① POWER switch

Press to turn the power ON or OFF.

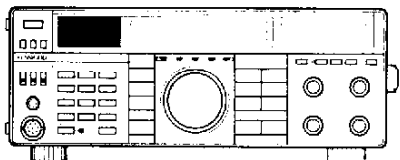

② Meter

During receive the meter is used as an S-meter. During transmit the function of the meter is controlled by the Meter switch ⑳, and provides either ALC level, or RF (power) readings.

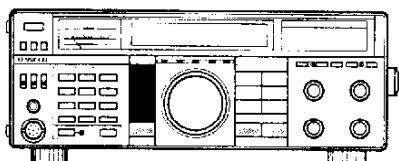

③ MODE keys

These keys are used to select the desired mode of operation. In CW mode the CW/N key is also used to select the desired filter bandwidth. When a MODE key is pressed the first character of that mode will be sounded in Morse code thru the internal speaker. This announcement can be inhibited by following the instructions in Section 4-2-5.

FM/AUTO key : Press the FM/AUTO key to alternate between FM and AUTO mode. (Please refer to Section 4-2-4.)

USB/LSB key : Press the USB/LSB key to alternate between USB and LSB.

CW/N key : Press the CW/N key to alternate between CW (SSB filter) and N (narrow).

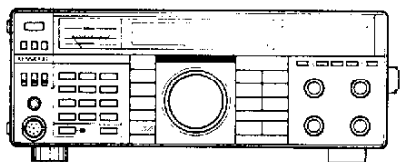

④ Indicators

ON AIR : Lights during transmit.

MAIN BUSY : On whenever the squelch is open.

F. LOCK : Light when the F. LOCK switch is ON.

SUB BUSY : On whenever the squelch is open.

ALT : Lights when the 1200 ALT switch is ON. (1200 MHz FM only)

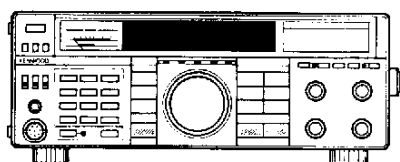

⑤ MAIN Display Panel

The fluorescent display tube displays operational information such as the operating frequency, memory channel information, and RIT information. (See page 16.)

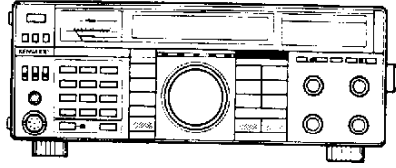

⑥ MAIN/SUB Indicators

MAIN : Lights when the MAIN key is ON.

SUB : Lights when the SUB key is ON.

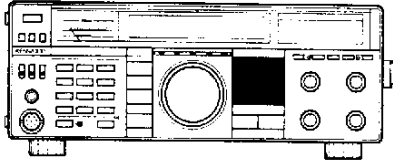

⑦ FUNCTION keys

MAIN : Used to set MAIN frequency and mode.

SUB : Used to set SUB frequency and mode.

A/B : Selects VFO A or VFO B.

VFO/M : Used to switch between memory or VFO operations.

MAIN \leftrightarrow **SUB**: Used to exchange data between the MAIN band and the SUB band.

A=B : Equalizes the frequencies and modes of VFO A and VFO B.

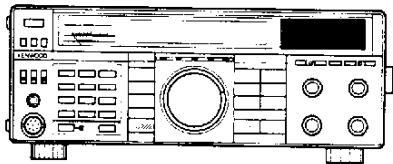

⑧ SUB RX Display Panel

The LCD Provides operational information such as the operating frequency and memory channel information. (See page 17.)

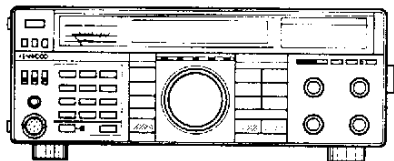

⑨ MAIN MUTE switch

Used to attenuate the MAIN audio by 12 dB. When turned on, the indicator on the right of the switch will turn red. When off, indicator is green if an incoming signal is present that opens the squelch. (See 6-6-3, MAIN audio mute control.)

Caution: _____

The indicator will not light when a signal is weak or absent. _____

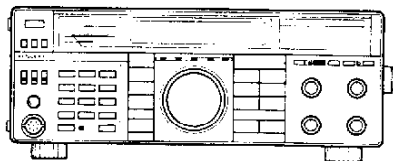

⑩ RIT switch

Press to turn the RIT ON or OFF. (MAIN band only)

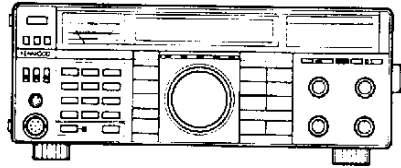

11 AGC FAST switch

This switch selects the operating time constant of the AGC (Automatic Gain Control) circuit. When the AGC switch is set to SLOW (■), the receiver gain and S-meter readings will react slowly to large input changes, and when set to FAST (■), the receiver gain and S-meter will react quickly to changes in the input signal level.

The normal position when using all modes is the SLOW position. When working any of the following you might wish to use the FAST position.

- When tuning.
- When receiving weak signals.
- When a high-speed CW signal is being received.

Note: _____
 This switch is disabled during FM operations.

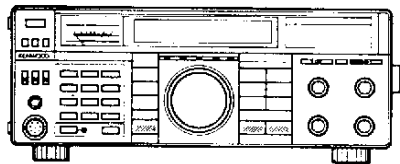

12 NB switch

For pulse type noise, such as generated by automotive ignition systems, turn the NB switch ON.

When pulsating noise, such as that caused by automobile ignitions is encountered, place the NB switch ON. This switch will not help to eliminate atmospheric or line noises, only pulse type noise.

Note: _____
 This switch is disabled during FM operations.

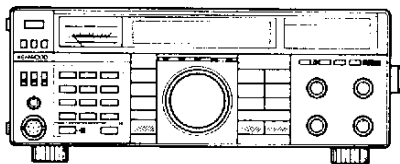

13 SUB MUTE switch

Used to attenuate the SUB audio by 12 dB. When turned on, the indicator on the left of the switch will turn red. When off, indicator is green if an incoming signal is present that opens the squelch. (See 6-6-2, SUB audio mute control.)

Caution: _____
 The indicator will not light when a signal is weak or absent.

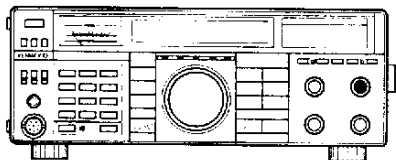

14 SUB AF gain control

Turn the knob to increase or decrease the volume. Clockwise rotation increases the volume and counter-clockwise rotation decreases the volume.

Note: _____
 The output level of the "Beep" is not affected by the setting of the AF gain control.

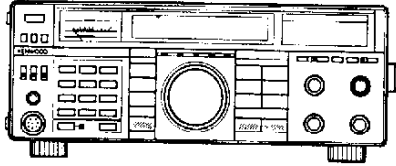

⑮ **SUB SQL (Squelch) control**

This control is used to eliminate atmospheric noise, and receiver static noise during no signal periods. Slowly rotate the control clockwise to the point where the ambient noise just disappears, and the speaker shuts off. This point is known as the squelch threshold point. Now you will only hear output from the speaker when an incoming signal is present. For weak signal reception this control should be fully counterclockwise.

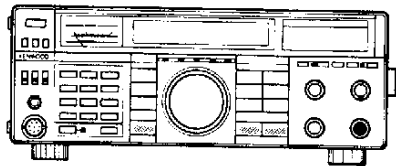

⑯ **MIC gain control**

Microphone gain can be adjusted during USB and LSB operations. This control should be adjusted so that the pointer on the meter remains within the ALC section marked on the meter.

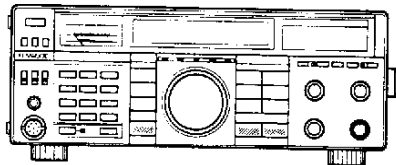

⑰ **RF PWR (Power) control**

Power can be controlled in all modes. Power is increased by turning the control to the right.

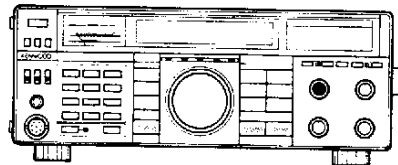

⑱ **MAIN AF gain control**

Turn the knob to increase or decrease the volume. Clockwise rotation increases the volume and counterclockwise rotation decreases the volume.

Note:

The output level of the "Beep" is not affected by the setting of the AF gain control.

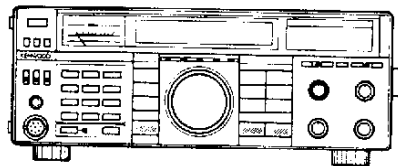

⑲ **MAIN SQL (Squelch) control**

This control is used to eliminate atmospheric noise, and receiver static noise during no signal periods. Slowly rotate the control clockwise to the point where the ambient noise just disappears, and the speaker shuts off. This point is known as the squelch threshold point. Now you will only hear output from the speaker when an incoming signal is present. For weak signal reception this control should be fully counterclockwise.

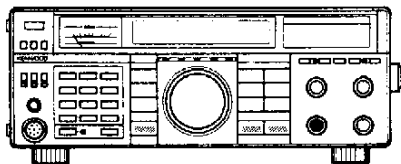

②① RIT control

When the transmit frequency of the distant station drifts a little bit during the QSO, but you do not wish to alter your transmit frequency to compensate, you may wish to make use of the RIT control function. This control allows shifting the receive frequency without shifting the transmit frequency. The RIT control allows you to shift the receiver frequency. This control is also useful for pileups when the DX station is transmitting a little above or below his receive frequency.

Notes:

1. The RIT offset is displayed on the main display. You can therefore preset the offset before you actually need to use it. When you move to another station make sure you turn OFF the RIT switch.
2. The figure below illustrates that the RIT display and the VFO display may not agree exactly in all instances since the RIT and VFO tune in 20 Hz steps. The main display resolution is 100 Hz, and would not show a change of 20 Hz. You would need to change the frequency at least 100 Hz to see an actual change in this display. (Except FM mode.)

VFO		RIT	
145.00000	0	0.0	0
144.99999	8	-0.0	2
144.99999	2	-0.0	8
144.99999	0	-0.1	0
144.99998	8	-0.1	2

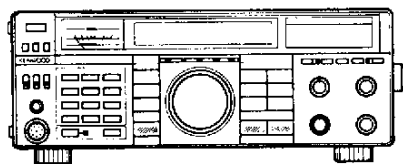

②① IF SHIFT control

The IF SHIFT control allows you to shift the IF pass-band of the receiver, without changing the actual center frequency of the receiver. This control is useful when there is interference near your center frequency.

Interference from lower frequencies can be reduced or eliminated by rotating the IF SHIFT control in the ⊕ direction. This will cause the resulting audio frequencies to have a slightly treble response, i. e. low cut filter (low frequencies attenuated). Interference from higher frequencies can be reduced or eliminated by rotating the IF SHIFT control in the ⊖ direction. This will cause the resulting audio frequencies to sound a little bassy, i.e. high cut filter (high frequencies attenuated).

Note:
The IF SHIFT control does not function in the FM mode.

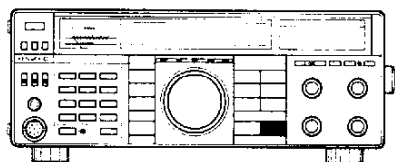
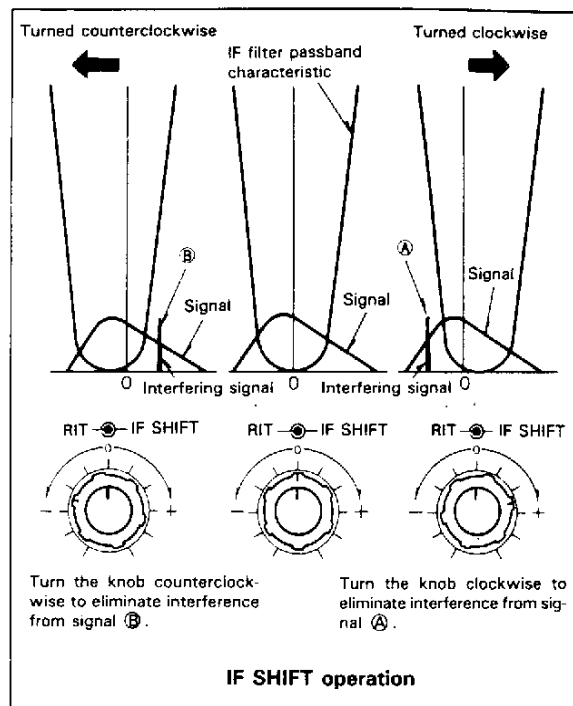

②② MHz switch

This switch is used to determine if the TUNING knob will shift the frequency in 1 MHz steps. When the 1 MHz step position is selected, the MHz indicator will light.

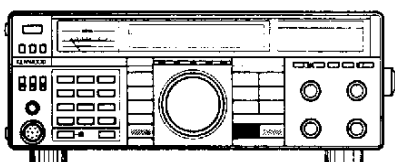

②③ BAND switch

Used to select a amateur radio frequency band. When MAIN and SUB bands are equal, the SUB display will read "OFF".

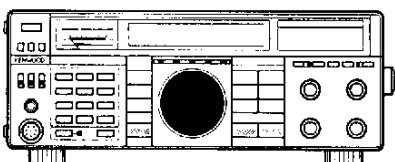

②④ TUNING knob (VFO)

Rotate the knob to select the desired frequency. Fast tuning is possible by rotating the knob rapidly. This knob may also be used to select the desired memory channel. The dial drag is adjustable by holding the outside knob and turning the inside knob clockwise to increase drag, and counterclockwise to decrease drag.

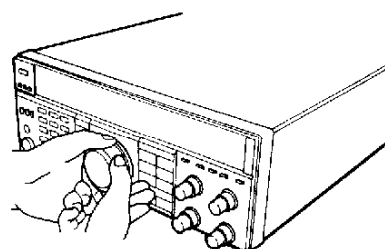

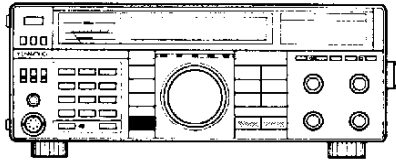

②⑤ CH.Q switch (Channel QSO abbreviated)

When in the VFO mode this switch selects either "channelized" (click type) or continuously variable tuning on the TUNING knob. When in the M (memory) mode channelized tuning is always selected.

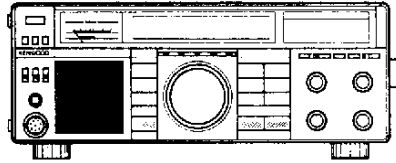

②⑥ Numeric key pad

Consists of a series of switches which will be used to set, turn on and/or turn off functions, and numeric keys used to enter frequency data directly. (See page 18.)

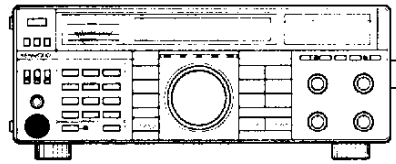

②⑦ MIC jack

Microphone connection.

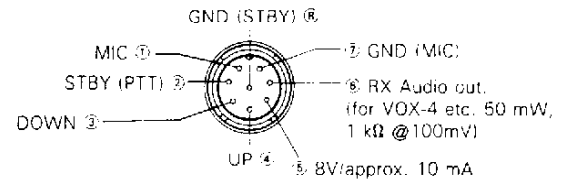

MIC connector (Front view)

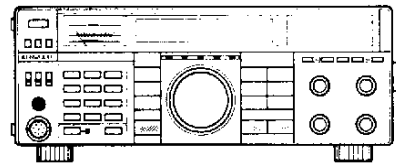

②⑧ PHONES jack

Output terminal for headphones.

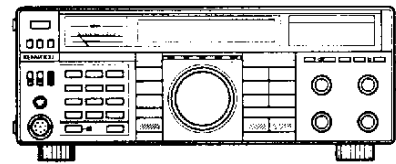

②⑨ ALC/RF meter switch

ALC meter

Used to monitor the drive level in USB and LSB modes. (SSB mode only)

RF meter

Used to indicate the output power.

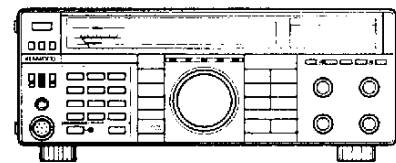

③⑩ PROC (Processor) switch

Effective transmit power output will increase when the PROC switch is turned ON during USB or LSB mode operations. (See 4-3-5, Speech Processor)

Note:

When the speech processor function is used in the USB or LSB mode it is possible to overdrive the transmitter. An easy way to check for excessive modulation is to monitor the ALC meter. If the needle is over the ALC zone you are overmodulating. Reduce the MIC gain control setting until the needle remains in the ALC zone on voice peaks.

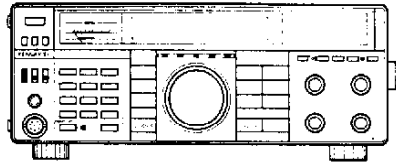

③① **VOICE switch**

Press this switch to activate the optional voice synthesizer unit VS-2.

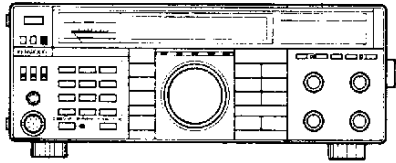

③② **1200 ALT switch (The optional UT-10 is required)**

This switch is used to activate the Automatic Lock Tuning system. See Section 4-2-12 for additional information on this switch.

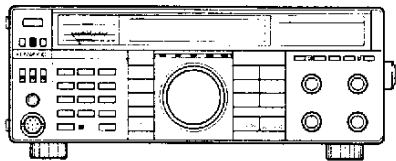

③③ **144 ATT (Attenuator) switch**

The incoming receive signal level is attenuated by approximately 10 dB when this switch is activated. When the incoming receive signal is very strong, the signal should be attenuated to prevent distortion of the signal, thereby stabilizing the receiver performance. This is easily done by activating the ATT switch. This control is also useful when a strong signal is near your desired signal, while some loss will occur to the desired signal as well as the undesired signal, the use of the attenuator will sometimes allow you to complete the QSO.

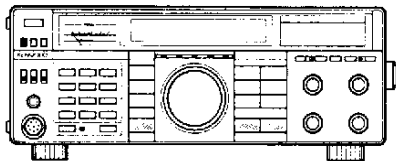

③④ **F. LOCK switch**

The selected dial frequency and mode are locked.

Note:

When the F. LOCK switch is on, RIT and MUTE functions are still active.

B. SUB RX Display Panel

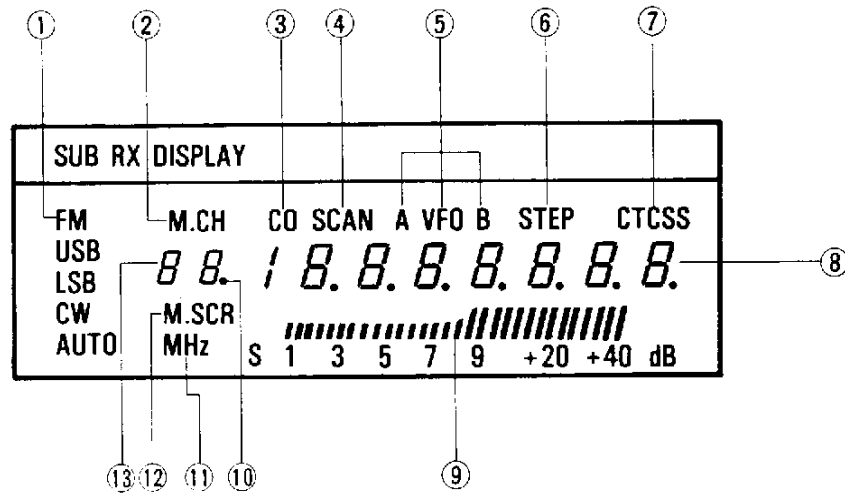

- | | | | |
|--|---|--|--|
| ① MODE display | : Indicates the selected mode. | ⑪ MHz display | : Turns on to indicate the MHz function is active. |
| ② M.CH display | : Turns ON during Memory Channel operation. | ⑫ M.SCR display | : Lights when the M.IN key is pressed. |
| ③ CO display | : Turns ON during Carrier Operate scan operation. | ⑬ Memory Channel number display | : Memory Channel Number is displayed. |
| ④ SCAN display | : Turns ON during scanning. | | |
| ⑤ VFO A/B display | : Turns ON when VFO A (or VFO B) is active. | | |
| ⑥ STEP display | : Lights when the STEP key is ON. | | |
| ⑦ CTCSS (Continuous Tone Coded Squelch System) display (TS-790A only) | : Turns on to indicate the CTCSS function is active. | | |
| ⑧ Frequency display | : Indicates the operating frequency. | | |
| ⑨ S-meter | : During receive the meter is used as an S-meter. | | |
| ⑩ ● display | : The ● display indicates the Memory Channel currently display will be skipped during Memory Channel scan. (Please refer to Section 4-5-3.) | | |

C. Keyboard

(1) OFFSET/SEL (select) key

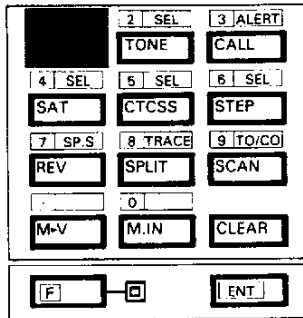

: The OFFSET key is used to select the desired transmitter offset during repeater operations. When the key is pressed, the shift modes cycle from + to - to simplex (no indicator).

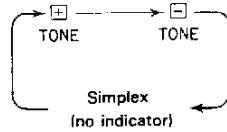

Caution:

This key is inoperative when:

- In modes other than FM.
- SUB is selected.



: You can select the offset frequency (shift width) with the TUNING knob or microphone UP/DOWN switch.

(With the TS-790A)

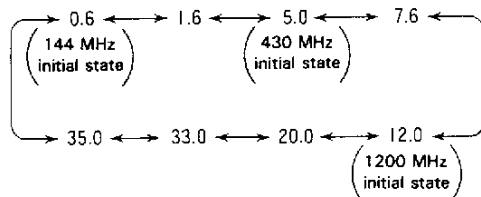

Caution:

This function is inoperative when:

- In modes other than FM.
- SUB is selected.

(With the TS-790E)

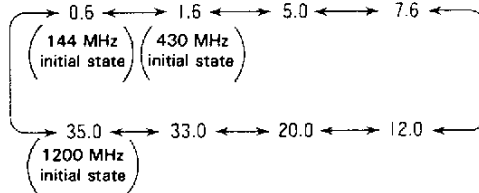

(2) TONE/SEL (select) key

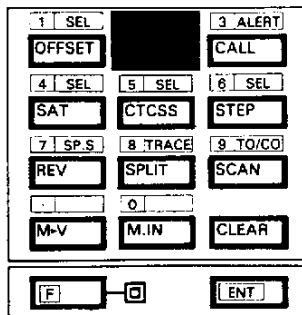

(With the TS-790A)



: Activates the tone circuit for repeater control. This key is also used to open the squelch of a distant station who has activated its CTCSS key.

(With the TS-790E)



Caution:

This key is inoperative when:

- In modes other than FM.
- SUB is selected.

(TS-790A only)

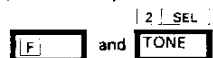

: Select the desired Tone Frequency using the UP/DOWN switches on the microphone or the TUNING knob. Refer to Section 4-6-4.

Caution:

This function is inoperative when:

- In modes other than FM.
- SUB is selected.

(3) CALL/ALERT key

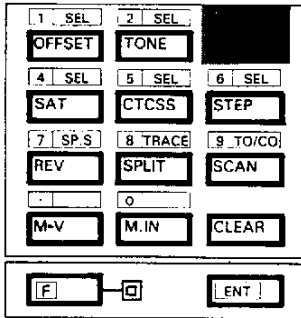

(with the TS-790A)



The CALL key selects the CALL channel (call frequency) with a single keystroke.

Note:

The FUNCTION keys will be locked when the CALL channel is in operation. When dual watch is desired by varying the CALL frequency and SUB VFO, use by combining the SUB VFO and memory channel in which the CALL frequencies are stored.

(with the TS-790E)



(TS-790A only)



This key is used to activate the priority alert function. See Section 4-5-5 Priority Alert for additional information on this function.

Caution:

This function is inoperative when SUB is selected.

(4) SAT (satellite)/SEL (select) key

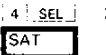
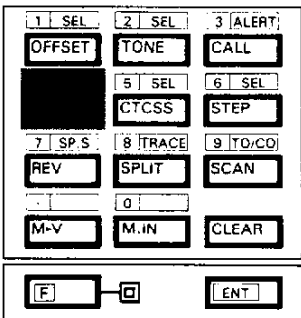

Turn ON for satellite communications. (See 4-9. SATELLITE COMMUNICATIONS.)



You can select the loop frequency of the up-link and down-link of the satellite communication used.

Caution:

This function is inoperative when SUB is selected.

(5) CTCSS/SEL (select) key

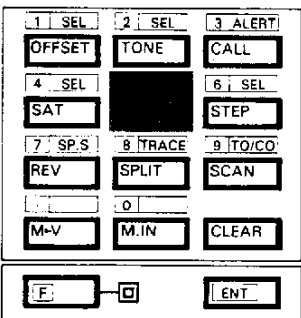

(with the TS-790A)



Refer to Section 4-7 TONE SQUELCH (CTCSS) for additional information on this key.

Cautions:

1. This key is operational in FM mode.
2. If no TSU-5 (Optional) is installed, the incoming received audio signals will be muted when this key is depressed.

(with the TS-790E)



This key is used to activate the priority alert function. See Section 4-5-5 Priority Alert for additional information on this function.

Caution:

This function is inoperative when SUB is selected.

(TS-790A only)

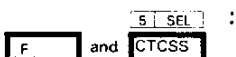

You can select the tone frequency with the TUNING knob or microphone UP/DOWN switch. (See 4-6-4. TONE OPERATION.)

(6) STEP/SEL (select) key

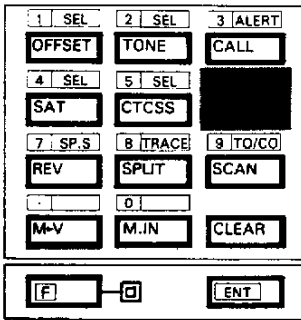

- [6] SEL STEP : Selects the size of the VFO frequency step. (Refer to section 4-2-6.)
- [F] and [6] SEL STEP : Select the desired frequency step using the TUNING knob or the microphone UP/DOWN switches.

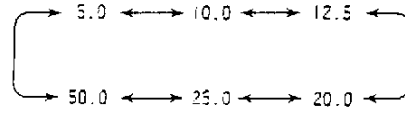

Caution: _____
This function is operational in FM mode.

(7) REV (Reverse)/SP.S (Speaker separate) key

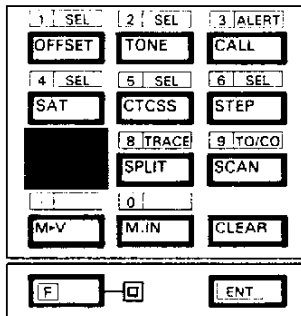

- [7] SP.S REV : When the REV key is depressed it is used to reverse the transmit/receive frequencies during repeater operations and split operations.

Caution: _____
This key is inoperative when SUB has been selected.

- [F] and [7] SP.S REV : Refer to Section 4-2-13. Separate speaker for additional information on this key.

(8) SPLIT/TRACE key

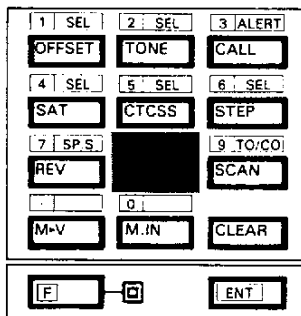

- [8] TRACE SPLIT : For split frequency operations; A-R, B-T (A receive, B transmit), or B-R, A-T.

Caution: _____
This key is inoperative when SUB has been selected.

- [F] and [8] TRACE SPLIT : Used to turn trace function on or off. (Refer to Section 4-8. TRACE FUNCTION)

(9) SCAN/TO/CO (Time operate/Carrier operate) key

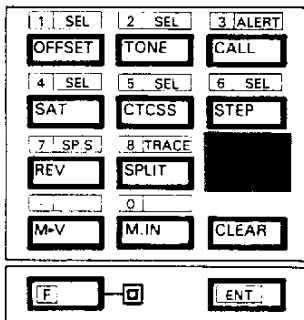

Press the SCAN key to initiate scanning, press again to cancel scan. For additional information on this function refer to Section 4-5 SCAN.



and



Used to select time-operated scanning or carrier-operated scanning.

Note: _____
The choice is made during scanning.

(10) M ► V key

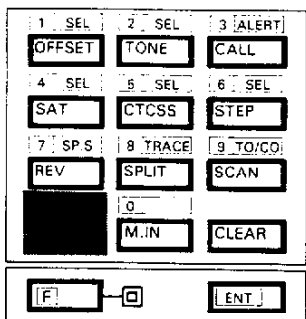

Used to transfer a frequency from memory to the VFO.

(11) M. IN key

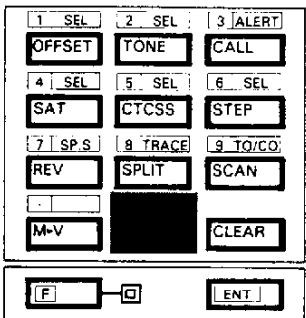

Used to enter data into a memory channel.

(12) CLEAR key

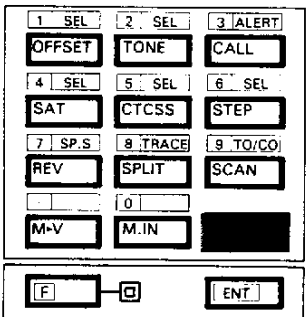

Used when reentering memory channel data, erasing a memory channel, clearing scan, when specifying the channels that will be skipped during scan operations, or to cancel an entry during direct keyboard entry of frequency.

(13) F (Function) key

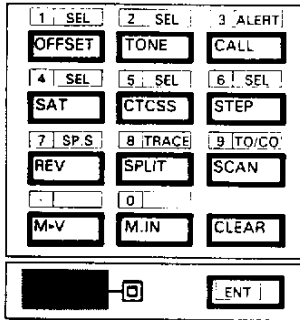

[F] : Used to activate various functions. When ON, the indicator lights at the right of the key.

(14) ENT (Enter) key

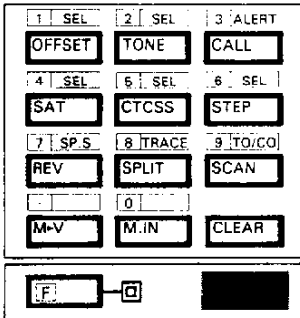

[ENT] : Used to directly enter a frequency from the numeric keypad. (Please refer to Section 4-2-10.)

4-1-2. Rear Panel

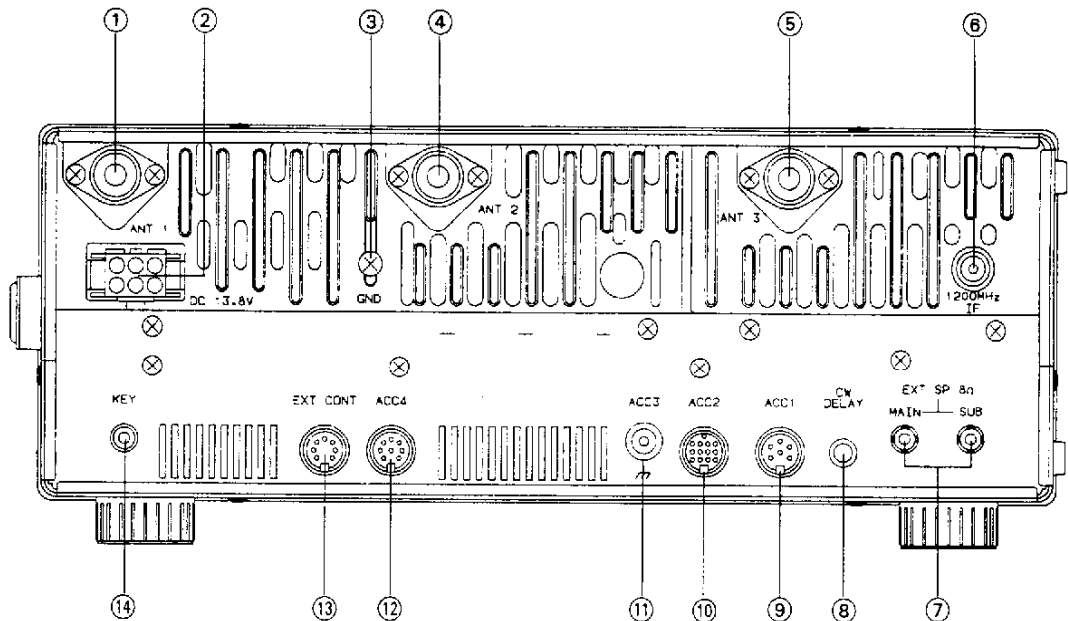

① ANT (Antenna) 1 connector (for 144 MHz)

This connector should be attached to a suitable antenna for transmitting and receiving. The antenna cable should be 50-ohm coax, terminated with a M type connector.

② DC power connector

This is used to connect the DC power supply.

③ GND (Ground) terminal

To prevent electric shock, as well as RFI and BCI, connect the transceiver to a good earth ground.

④ ANT (Antenna) 2 connector (for 430/440 MHz)

This connector should be attached to a suitable antenna for transmitting and receiving. The antenna cable should be 50-ohm coax, terminated with a M type connector. (N type connector with the TS-790E)

⑤ ANT (Antenna) 3 connector (for 1200 MHz) (Option)

This connector should be attached to a suitable antenna for transmitting and receiving. The antenna cable should be 50-ohm coax, terminated with a N type connector.

⑥ 1200 MHz IF connector (Option)

Used to remove or input 1200 MHz IF signal. (See 4-13. 1200 MHz IF CONNECTOR AND ACC4 CONNECTOR.)

⑦ EXT. SP (External speaker) jack

This jack is for connection of an external speaker. You can connect one or two external speakers. (See 4-2-13 Separate speaker.)

⑧ CW DELAY control

This control adjusts the "hang-time" that the radio will remain keyed after the key has been released.

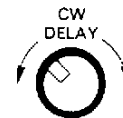

⑨ ACC 1 jack

This jack is designed for connection of the 6-pin DIN connector supplied with the optional computer interface unit.

⑩ ACC 2 jack

Terminal numbers is as follows:

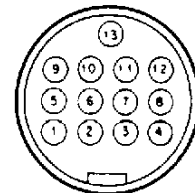

View from the rear panel.



13-pin DIN plug (E07-1351-05)

⑪ ACC 3 jack

The front-panel 144ATT switch can be used to control an external pre-amplifier for example when switch SW1 (IF unit X48-3050-XX) is placed to the rear as shown in the accompanying figure.

Cautions:

1. The 144ATT switch cannot be used to control internal receiver gain when the ACC3 jack is used.
2. The outer conductor of the jack is grounded.

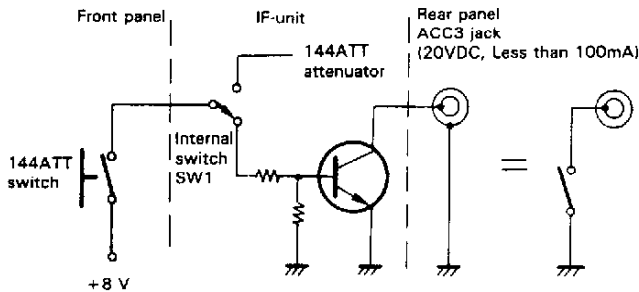

Caution:
Do not try to drive a relay directly.

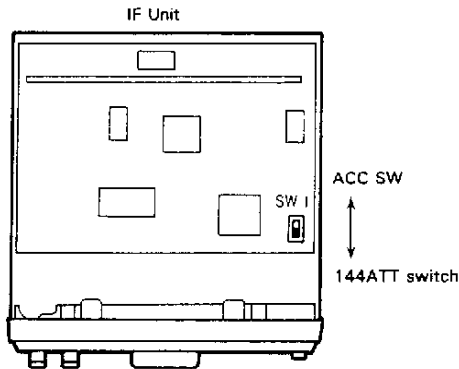

⑫ ACC4 connector

This connector can be used to control an Amateur TV terminal unit.

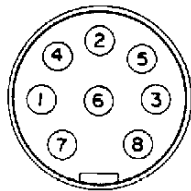

ACC4 View from the rear panel.

ACC4 pin assignments

Pin number	Symbol	Use
1	ALC	Output of internal ALC voltage.
2	GND	Ground.
3	N C	Unused.
4	CNT	When 5 to 12 V is applied to this terminal, the transmitter IF signal to the RF unit will be blocked.
5	N C	Unused.
6	12TXB	Voltage of about 8.8 V is output during transmission at 1200 MHz (maximum permissible output current 50 mA).
7	C B	The DC supply voltage applied to the power terminal will be available at this terminal via a choke coil and the power switch (maximum permissible output current 100 mA).
8	S S	External push to talk terminal transmission starts when grounded (voltage approximately 5 V).

⑬ EXT CONT connector

Used to control external devices like a linear amplifier. Use the 7-pin DIN plug provided.

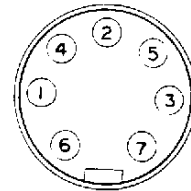

EXT CONT View from the rear panel.

Downloaded by
Amateur Radio Directory

www.hamdirectory.info

EXT CONT pin assignments

Pin number	Symbol	Use
1	43TXG	Grounded during transmission in 430 MHz band. Normally at high impedance. (Maximum permissible voltage 20 V, maximum permissible current 10 mA).
2	S S	External push to talk terminal transmission starts when grounded.
3	ALC	External ALC input ①. ALC threshold is about -6 V.
4	12TXG	Grounded during transmission in 1200 MHz band. Normally at high impedance. (Maximum permissible voltage 20 V, maximum permissible current 10 mA). (Optional in the TS-790A/790E).
5	ALC	External ALC input ②. ALC threshold is about -6 V.
6	14TXG	Grounded during transmission in 144 MHz band. Normally at high impedance. (Maximum permissible voltage 20 V, maximum permissible current 10 mA).
7	ALC	External ALC input ③. ALC threshold is about -6 V.

4-1-3. Microphone

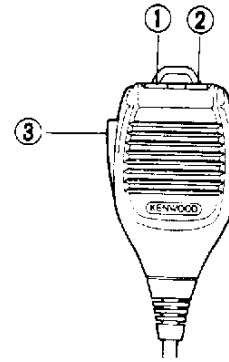

① ② UP/DWN (Up/Down) switches

These switches are used to step the VFO frequency or memory channel up and down. The frequency will change continuously if the switches are pressed and held.

③ PTT (Push To Talk) switch

The transceiver will be placed into Transmit whenever this switch is pressed. Scan will be cleared when this switch is pressed.

Reference information

- Circuit of each TXG (pin numbers 1,4, and 6).

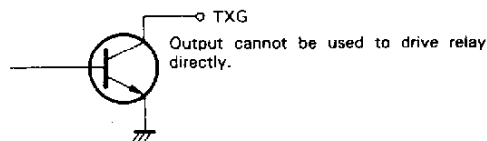

- Circuit of ALC

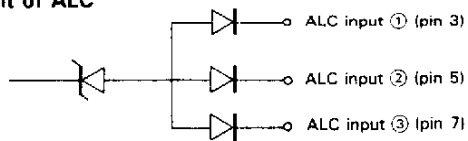

⑭ KEY jack

Using shielded line, connect a 1/8" phone plug to this jack for CW operation. Open-terminal voltage is approximately 5.5 VDC.

4-2. RECEIVER OPERATION

Different MAIN and SUB band frequencies can be received simultaneously. Reduce the audio of the band you do not want to hear. You can turn off SUB-band audio, if you do not need it, with the BAND switch. (See 4-2-7. Band switch). A beep will follow pressing any key.

4-2-1. Receiving

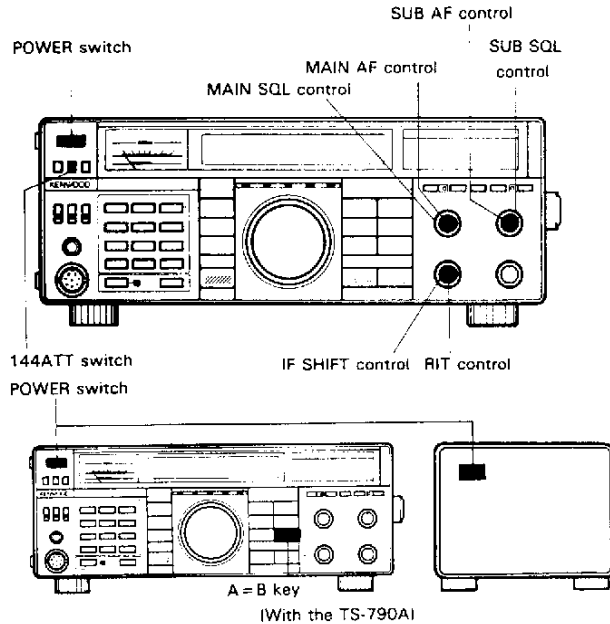

1. Connect the power supply and the antenna, and then set the switches and controls as follows:

- POWER switch : OFF ()
- POWER switch of the DC power supply (Fixed Station) : OFF ()
- MAIN SQL control : Fully counterclockwise
- SUB SQL control : Fully counterclockwise
- MAIN AF control : Fully counterclockwise
- SUB AF control : Fully counterclockwise
- RIT control : Center
- IF SHIFT control : Center
- 144ATT switch : OFF ()

Turn on the DC power supply and then turn the transceiver's power switch ON. The display panel will indicate as shown below.

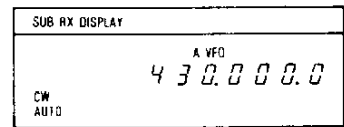
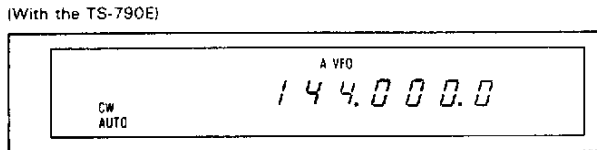
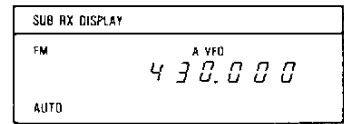
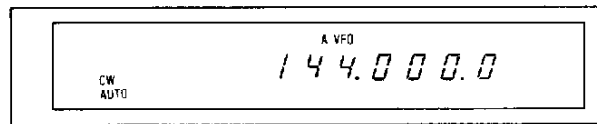

Note:

If the display is not as shown reset the microprocessor using the procedure in Section 4-4-2.

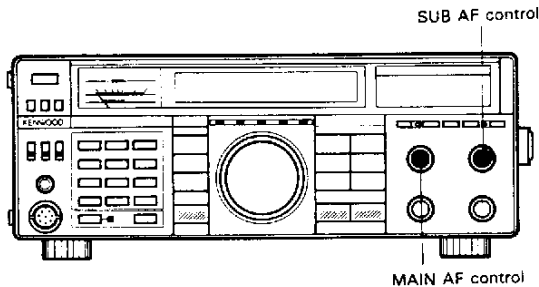

3. Turn the AF control clockwise until a signal or noise is heard.

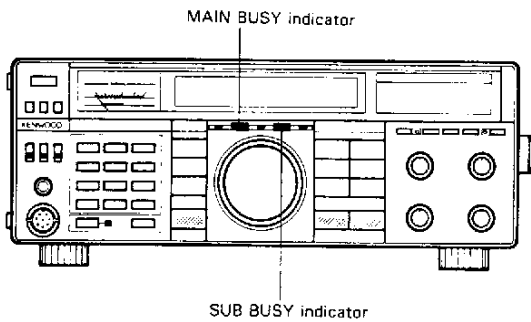
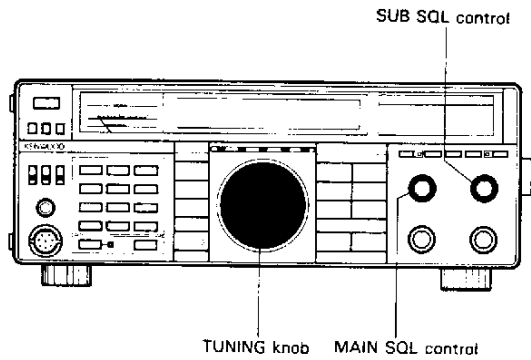

4. Rotate the TUNING knob and select an open channel. Then turn the SQL control clockwise until the noise just disappears.

5. Select the desired operating frequency. When a signal is received, the BUSY indicator will turn on and the S-meter will deflect.

6. To turn off the transceiver, turn off the transceiver's POWER switch before you turn off the power supply, or if in a vehicle, before you stop the engine.

4-2-2. Beep Tones

Audible confirmation of microprocessor functions is provided in the form of a series of audio beeps. The output level of the "Beeper" is adjustable with a variable resistor located inside the set. (Please refer to Section 6-6-5.)

4-2-3. Audible Mode Announcement

When a Mode key is pressed, the first character of the mode is sounded in Morse code thru the speaker.

Mode	Morse Code
FM	· · · ·
AUTO	· —
USB	· · —
LSB	· — · ·
CW (Wide)	— · · · ·
CWN (Narrow)	— ·

Note:

You can select a single audio beep rather than Morse Code confirmation by pressing the CW/N key when turning on the power switch. (Please refer to Section 4-2-5.)

4-2-4. AUTO mode

The AUTO mode function automatically sets the mode to correspond to the selected frequency as shown below, which is especially convenient for operations.

Note:

AUTO mode selection will not function when using RIT.

1. 144 MHz Band (With the TS-790A)

144.0	144.1	144.5	145.8	146.0	148.0
CW	USB	FM	LSB	FM	

(With the TS-790E)

144.00	144.15	144.50	145.80	146.00
CW	USB	FM	LSB	

2. 430 MHz Band (With the TS-790A)

430.0	435.0	438.0	450.0
FM	USB	FM	

(With the TS-790E)

430.0	432.15	432.5	435.0	438.0	440.0
CW	USB	FM	USB	FM	

3. 1200 MHz Band (Option) (With the TS-790A)

1240	1260	1270	1300
FM	LSB	FM	

(With the TS-790E)

1240	1260	1270	1296	1296.15	1297	1300
FM	LSB	FM	CW	USB	FM	

4-2-5. Power on function selection

The functions of this transceiver can be changed at the time the transceiver is turned ON. Repeat when releasing each function.

Key	These functions include
CW/N	Audible mode announcement: Beep tones/Morse code

4-2-6. Frequency Step

1. The frequency step is set automatically depending on the mode that has been selected.
(With the TS-790A)

Mode		SSB/CW	FM
CH.Q	STEP		
OFF	OFF	20 Hz	100 Hz
	ON	100 Hz	100 Hz
ON	OFF	5 kHz	2 m band: 5 kHz Other band: 25 kHz
	ON	1 kHz	2 m band: 10 kHz Other band: 5 kHz

(With the TS-790E)

Mode		SSB/CW	FM
CH.Q	STEP		
OFF	OFF	20 Hz	100 Hz
	ON	100 Hz	100 Hz
ON	OFF	5 kHz	2 m band: 12.5 kHz Other band: 25 kHz
	ON	1 kHz	5 kHz

2. When the TUNING knob is rotated at about 3 revolutions a second a geometric increase in the tuning step occurs that corresponds to the speed of dial rotation. (When CH.Q switch is OFF.)

4-2-7. Band switch

Press the BAND switch to change amateur radio bands.

1. When MAIN is selected.

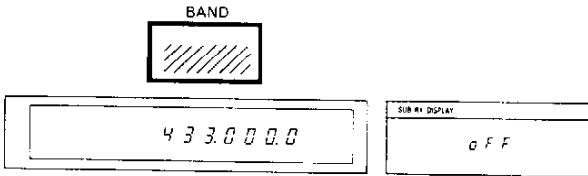
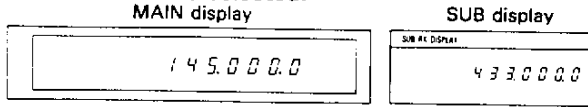

When MAIN and SUB bands are equal, the SUB display reads "OFF".

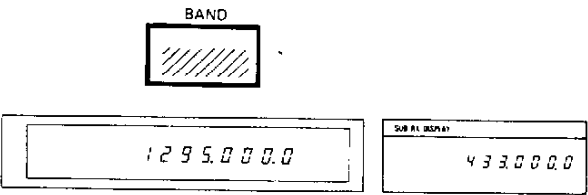

(Optional in the TS-790A/790E.)

2. When SUB is selected.

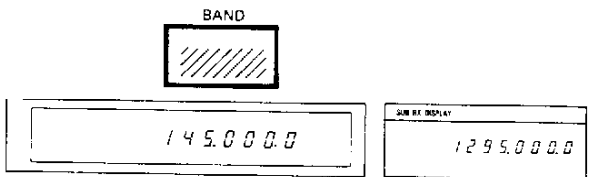
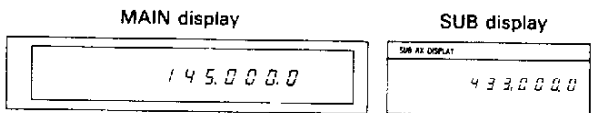

(Optional in the TS-790A/790E.)

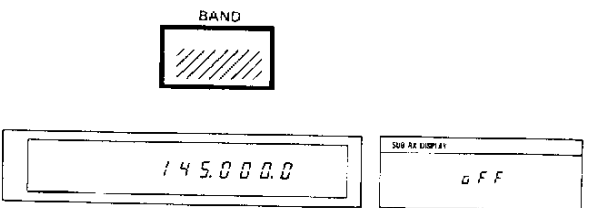

When MAIN and SUB bands are equal, the SUB display reads "OFF".

4-2-8. Exchanging MAIN and SUB bands

Press the MAIN \rightleftharpoons SUB key to exchange the MAIN and SUB bands data.

Caution:

When the SUB display reads "OFF", you cannot exchange MAIN and SUB bands data.

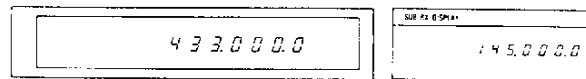
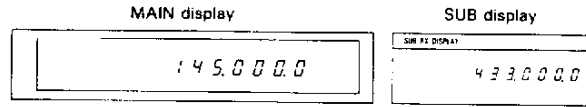

4-2-9. Dual Digital VFO's

Operational convenience is enhanced thru the use of both VFO A and VFO B.

Two VFO's are provided to allow you to change frequencies rapidly. For example; you could set one VFO to the lower tuning range and the other VFO to the upper tuning limit. You can set either VFO to any frequency you desire.

(a) A = B key

Depressing this key causes the data contained in the inactive VFO (the VFO that is not currently being displayed) to change to the same data contained in the active VFO (the one currently displayed). Both the frequency and mode selection are changed.

For example:

VFO A is set at 145 MHz in AUTO, and VFO B is 144 MHz in CW. VFO A is the active VFO (show on the display). Depressing the A = B key will cause VFO B to change to 145 MHz in AUTO.

(b) A/B key

Allows selection of the desired active VFO. Each time this key is depressed the active VFO will alternate between VFO A and VFO B.

4-2-10. Direct keyboard frequency entry

Direct keyboard entry of the frequency is possible using the Numeric Keypad on the TS-790A/E. This allows rapid changes in frequency without the delays encountered when using other tuning methods.

Cautions:

1. You cannot directly enter SUB frequency data that is the same as the MAIN band when using the numeric keys.
2. Similarly, you cannot enter any frequency which is outside the coverage of the radio.

1. Select the VFO mode.
2. Press the ENT key. The display will indicate.



(When CH.Q switch is OFF.)

3. Enter the desired operating frequency from Most Significant Digit to the Least Significant Digit. You do not have to enter trailing zeros, but you must enter leading zeros.

Cautions:

1. When entering a 144 MHz band frequency, press the "." (decimal point) key following the appropriate numeric keys.
2. When entering a 430 MHz or 1200 MHz band frequency, you need not press the "." (decimal point) key.

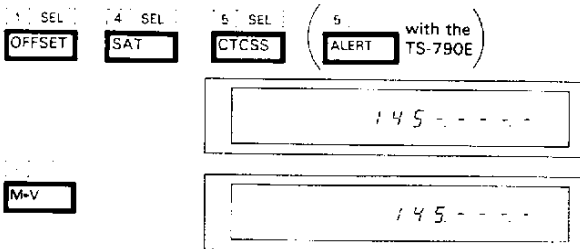

4. After the least significant digit has been entered press the ENT key again to signify you want the radio to change frequency. If you entered the frequency down to the nearest 100 Hz a beep will sound and the radio will automatically change to the new frequency without the need of pressing the ENT key for the second time.

For example:

To enter 435.000.0 MHz there are two methods:

Method one: Press [ENT], [4], [3], [5], [ENT]

Method two: [ENT], [4], [3], [5], [0], [0], [0], [0]

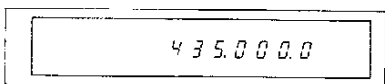

5. If you make a mistake while entering the frequency and have not yet pressed the ENT key, or entered the final digit, you may cancel the input by pressing the CLEAR key.

4-2-11. CW zero-beat Operation

When the optional filter is not installed, rotate the TUNING knob so that the receive beat frequency is approximately 800 Hz.

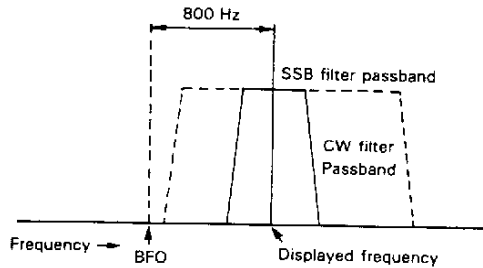

4-2-12. ALT (Auto Lock Tuning) System (Optional in the TS-790A/790E)

The ALT system operates similar to an AFC (Automatic Frequency Control) system. This system is useful when the frequency of either station starts to drift. When this occurs distortion of the signal is the usual result. The ALT system will correct for this apparent drift.

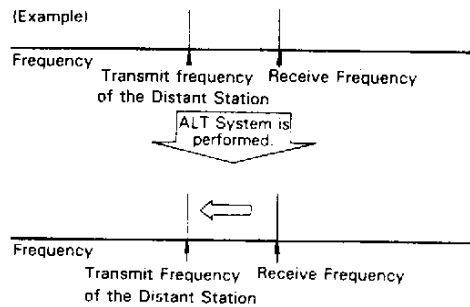

Note:

The frequency display will not change, even though the receive frequency might shift in order to properly tune the incoming signal.

Caution:

The ALT function will turn off if you turn on ALT during Memory Channel operation and transfer to another memory channel or VFO operation.

4-2-13. Separate Speaker

When you turn on the SP.S key, MAIN and SUB receiver audio will come out independently. If you position the external speaker(s) carefully, you can discriminate between the MAIN and SUB audio signals.

1. Press the F key and then the REV key. The MAIN display will read "SP.S".
2. To release the function, press the F-and-REV key again.

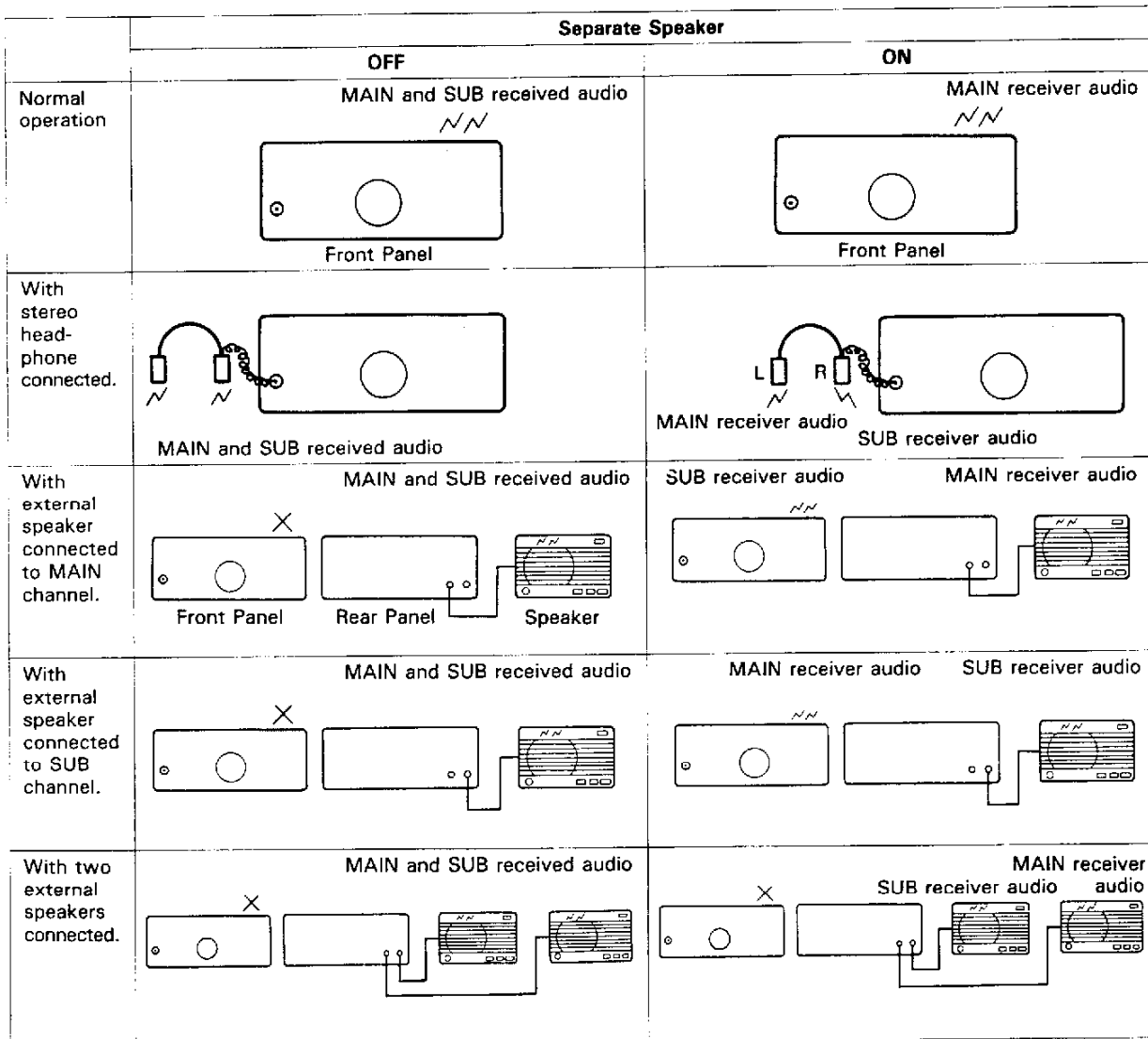

Downloaded by
 Amateur Radio Directory

www.hamdirectory.info

4-3. TRANSMITTER OPERATION

The MAIN channel is used for transmission. The SUB channel is ready for reception even while transmitting on the MAIN channel (unless "OFF" is indicated in the SUB display).

You can utilize this feature for communication via satellite or for full duplex operations. The system will function as an ordinary transceiver when you do not use the SUB channel.

4-3-1. Precaution

Before transmitting check the frequency for activity so that you do not interrupt another QSO.

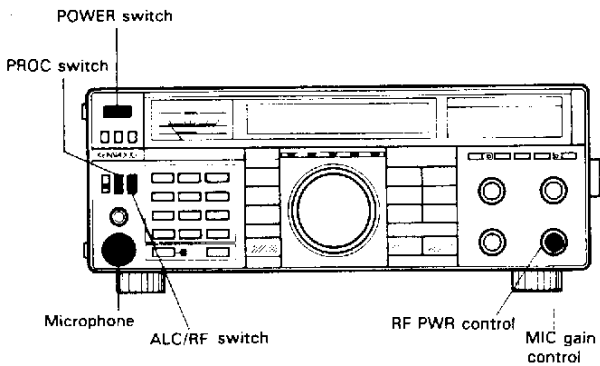

1. Set the switches and controls as follows:

- Power switch : OFF ()
- PROC switch : OFF ()
- ALC/RF switch : ALC ()
- MIC control : Fully counterclockwise
- RF PWR control : Fully clockwise

2. Connect a microphone to the MIC jack.

4-3-2. FM Mode

1. Place the POWER switch ON.
2. Press the FM mode key.
3. Enter the desired frequency (Shown in the MAIN display).
4. Press the microphone PTT switch. The ON AIR indicator will light.
5. Speak into the microphone, holding the microphone about 5cm away from your mouth. Close talking or talking too loudly may reduce transmission clarity or spread the side bands too much.
6. Release the PTT switch. The ON AIR indicator will turn OFF.

4-3-3. SSB (LSB, USB) Mode

1. Place the POWER switch ON.
2. Press the LSB or USB mode key.
3. Enter the desired frequency (Shown in the MAIN display).
4. Press the microphone PTT switch. The ON AIR indicator will light.
5. Speak into the microphone and adjust the MIC gain control so that the meter deflection does not exceed the ALC zone on voice peaks.

Note:

Adjustment using the ALC meter provides greater accuracy than if you try and use the power meter for adjustment. Never adjust for ALC deflection above the ALC zone, as this will cause distortion of the transmitted audio signal.

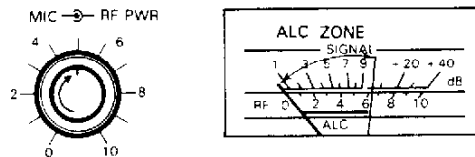

6. Turn on the PROC switch if required. (Please refer to Section 4-3-5)
7. Release the PTT switch. The ON AIR indicator will turn OFF.

4-3-4. CW Mode

Sidetone oscillator

The transceiver contains a sidetone oscillator circuit to permit you to monitor your own signal. If the key is closed in a mode other than CW, transmit will not be selected but sidetone will come out of the speaker, to allow Morse code training. The volume of the sidetone can be adjusted internally. (Please refer to Section 6-6-4)

Semi-automatic break-in

Depressing the CW key will automatically place the transceiver into the transmit mode. Transmit will be maintained for a period determined by the setting of the CW DELAY control on the rear panel of the transceiver, even after the CW key is released.

CW
DELAY



The further you turn the control clockwise, the more time it will take until receive is restored.

1. Connect a key or electronic keyer to the rearpanel KEY jack.
2. Place the POWER switch ON.
3. Set MODE keys to CW if required.
4. Enter the desired frequency (Shown in the MAIN display).
5. Press the key; the ON AIR indicator lights and the meter pointer deflects.
6. Release the key. Reception mode will be restored with the ON AIR indicator turned off.

4-3-5. Speech Processor

The Speech Processor is used when signals from your station are weak at the distant station.

Notes:

1. Intelligibility is normally reduced when the speech processor is used.
2. This function is not useful in the FM mode.

Speak into the microphone and adjust the MIC gain control so that the meter deflection does not exceed the ALC zone on voice peaks.

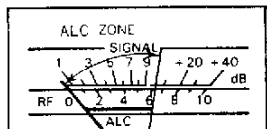
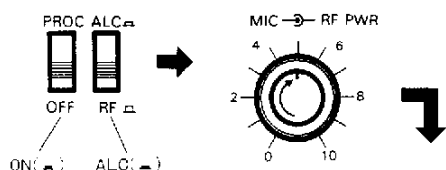

4-3-6. VOX (Voice Operated Switch)

Switching between transmit and receive can be voice controlled in the SSB, FM and AM modes by using the optional VOX-4 unit. The operators manual supplied with the VOX-4 contains instructions for its use. The processor should not be used when the VOX-4 is ON. When operating in the CW mode the VOX GAIN on the VOX-4 should be adjusted for minimum (OFF), since voice inputs would tend to cause the radio to transmit.

4-3-7. Split Frequency Operation

Allows the use of one VFO for transmit, and the other for receive (Split Frequency operation).

For example:

VFO A is the active VFO, and VFO B is the inactive VFO. Depressing the SPLIT key will cause the transceiver to receive on VFO A and transmit on VFO B. The mode of reception and transmission will follow the mode contained in the appropriate VFO memory. It is possible to work cross band, cross mode if desired.

To avoid confusion during contest, or pile-up operations we recommend using VFO A for receive and VFO B for transmit.

4-3-8. Duplex Operation

Pushing the PTT switch on the microphone allows the simultaneous reception in the SUB band frequency and sending in a MAIN band frequency.

Note:

With certain relationship between the sending and receiving frequencies, the receiver sensitivity may be suppressed.

4-4. MEMORY

The TS-790A/790E incorporates a convenient 59 channel memory that can be used to store and recall commonly used frequencies.

4-4-1. Microprocessor back-up lithium Battery

A lithium battery is contained in the transceiver to retain memory. Turning off and POWER switch, disconnecting the power cable, or a power failure will not erase the memory. The battery should last for approximately five years. When the battery discharges, an erroneous display may appear in the display. Lithium battery replacement should be performed by an authorized KENWOOD service facility; either your KENWOOD dealer, or the factory, since this unit contains CMOS type circuitry.

Notes:

1. When the lithium battery is replaced, the microprocessor must be reset, using the procedure in section 4-4-2.
2. When the lithium battery fails, the radio's microcoded functions are not affected. Only information stored in memory will be cleared.

4-4-2. Initial state and reset of the microprocessor.

A. Initial state of the microprocessor from the factory.

(With the TS-790A)

MHz		MAIN display		SUB display	
		Frequency	Mode	Frequency	Mode
144	VFO A,B	144.000.0	AUTO, CW	430.000	AUTO, FM
430	VFO A,B	430.000	AUTO, FM	OFF	
*1200	VFO A,B	1240.000	AUTO, FM	430.000	AUTO, FM

(With the TS-790E)

MHz		MAIN display		SUB display	
		Frequency	Mode	Frequency	Mode
144	VFO A,B	144.000.0	AUTO, CW	430.000.0	AUTO, CW
430	VFO A,B	430.000.0	AUTO, CW	OFF	
*1200	VFO A,B	1240.000	AUTO, FM	430.000.0	AUTO, CW

Memory Channel	Frequency	Mode
00 ~ 49	. .	—
P1, P2, P3*	. .	—
A1, A2, A3*	. .	—
C1	145.000	AUTO, FM
C2	433.000	AUTO, FM
*C3	1295.000	AUTO, FM

(*: Optional in the TS-790A/790E.)

B. Microprocessor reset

There are two methods for resetting the microprocessor.

1. Press and hold the A=B key and turn on the POWER.

Caution:

All user programmed memory will be erased with this operation.

2. Press and hold the A/B key and turn on the power to reset all user programmed data except the contents of the Memory Channels.

4-4-3. Memory Channel Organization

Memory Channel Number	Memory Channel
00 through 29	Standard
30 through 49	Split
P1, P2, P3*	Programed Scan
A1, A2, A3*	Alert
C1, C2, C3*	Call

(*: Optional in the TS-790A/790E.)

4-4-4. Memory Contents

Each Memory Channel is capable of storing the following information:

	00-29	30-49	P1, P2, P3*	A1, A2, A3*	C1, C2, C3*
Frequency	○	○	○	○	○
Mode	○	○	○	○	○
SHIFT status	○	×	×	○	○
Tone Frequency data	○	○	○	○	○
Tone ON/OFF	○	○	○	○	○
CTCSS	○	○	○	○	○
CH. Q	○	○	○	○	○

(*: Optional in the TS-790A/790E.)

P1, A1, C1 are for 2 meters.

P2, A2, C2 are for 70 cm.

P3, A3, C3 are for 1200 MHz.

4-4-5. Memory Entry

A. Standard Memory Channel

1. Select the receive frequency and the mode.

Example:

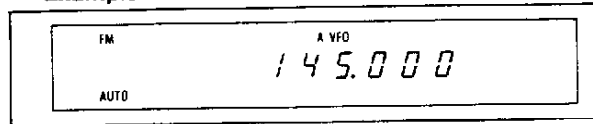

2. Press the M.IN key. The radio will enter the Memory Scroll (M.SCR) mode.

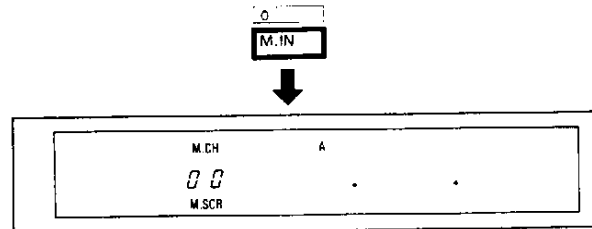

3. Select the desired Memory Channel number.

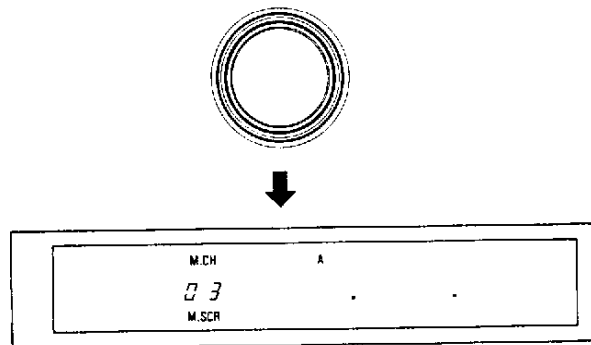

4. When the desired memory channel is found and displayed, press the M.IN key again. The current frequency and mode will be stored, the Memory Scroll mode will be cancelled, and the TS-790A/790E will return to the operating mode and frequency that was displayed before the M.IN key was pressed initially.

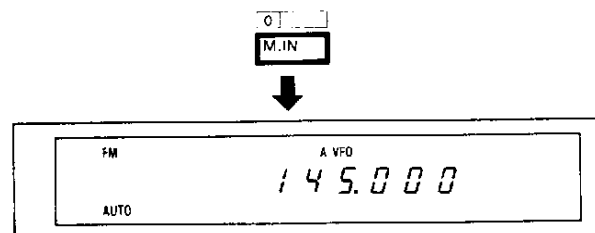

B. Split Memory Channel

1. Select the receive frequency and the mode.

Example:

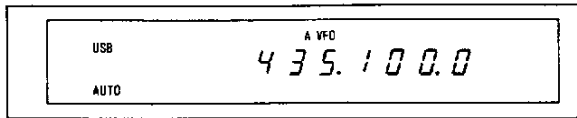

2. Press the A=B key and then press the A/B key.

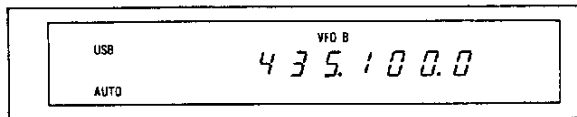
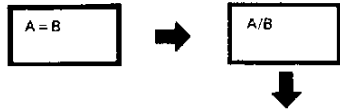

3. Select the transmit frequency.

Example:

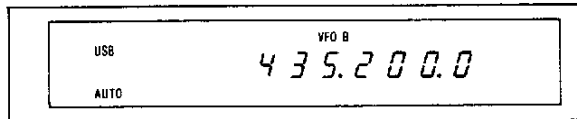

4. Press the A/B key.

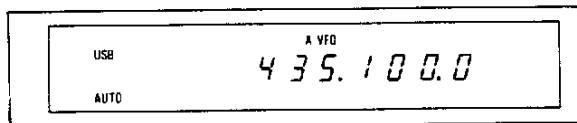
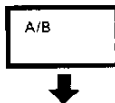

5. Press the M.IN key.

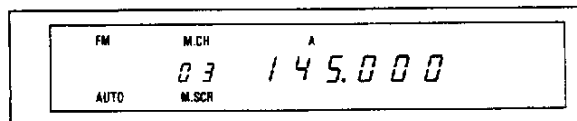

(When 145.000 MHz is stored in Memory Channel 03.)

6. Select the desired Memory Channel number.

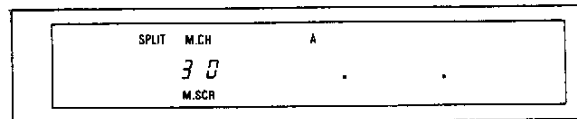

7. When the desired memory channel is found and displayed, press the M.IN key again. The current frequency and mode will be stored, the Memory Scroll mode will be cancelled, and the TS-790A/790E will return to the operating mode and frequency that was displayed before the M.IN key was pressed initially.

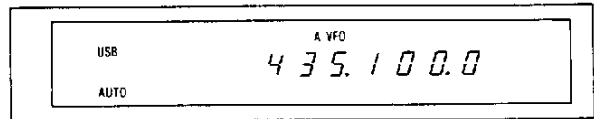
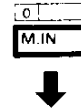

C. Programed Scan Memory Channel

1. Select the lowest operating frequency and the mode.

Example:

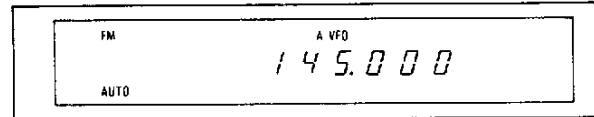

2. Press the A=B key and then press the A/B key.

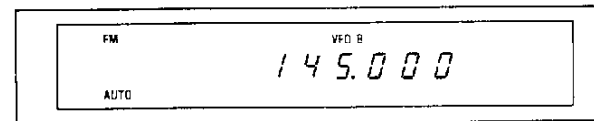
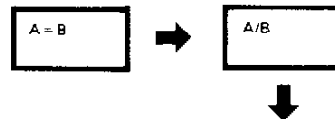

3. Select the highest operating frequency.

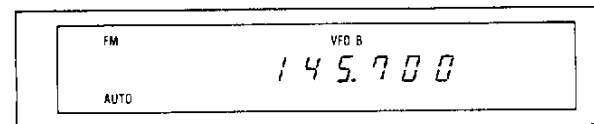

4. Press the A/B key.

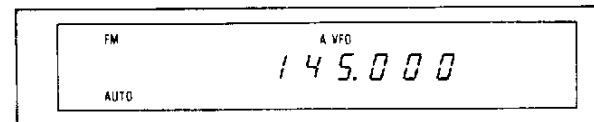
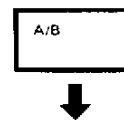

5. Press the M.IN key.

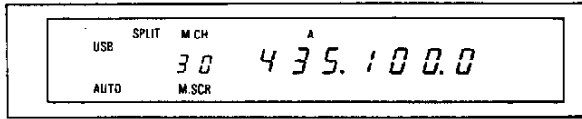

(When 435.100.0 MHz is stored in Memory Channel 30.)

6. Select the desired programed scan memory channel number. P1 for 2 meters, P2 for 70 cm or P3 for 1200 MHz.

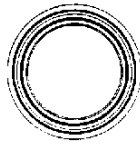

144 MHz Band

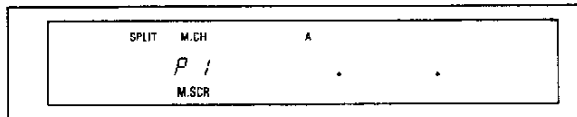

430 MHz Band

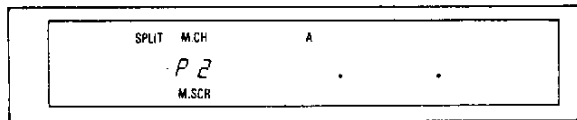

1200 MHz Band (Optional in the TS-790A/790E).

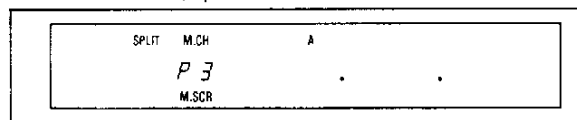

7. When the desired program scan memory channel is found and displayed, press the M.IN key again. The current frequency and mode will be stored, the Memory Scroll mode will be cancelled, and the TS-790A/790E will return to the operating mode and frequency that was displayed before the M.IN key was pressed initially.

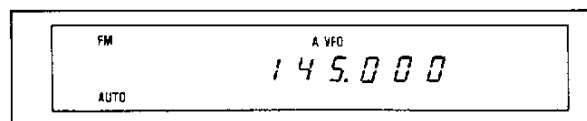

D. Alert Channel

1. Select the receive frequency and the mode.

Example:

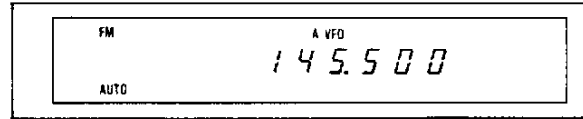

2. Press the M.IN key.

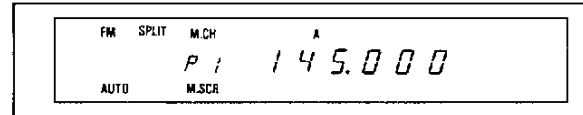

(When 145.000 MHz is stored in Memory Channel P1.)

3. Select the desired alert channel number.

A1 for 2 meters, A2 for 70 cm or A3 for 1200 MHz.

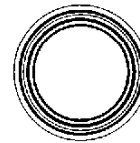

144 MHz Band

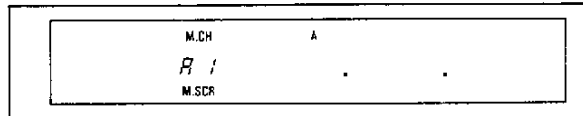

430 MHz Band

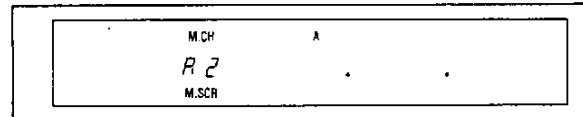

1200 MHz Band (Optional in the TS-790A/790E).

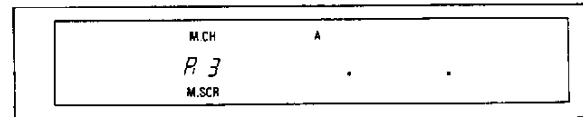

4. When the desired alert memory channel is found and displayed, press the M.IN key again. The current frequency and mode will be stored, the Memory Scroll mode will be cancelled, and the TS-790A/790E will return to the operating mode and frequency that was displayed before the M.IN key was pressed initially.

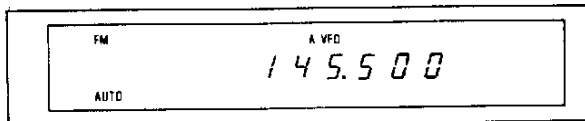

E. Call Channel

1. Select the receive frequency and the mode.

Example:

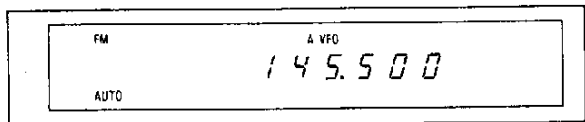

2. Press the M.IN key.

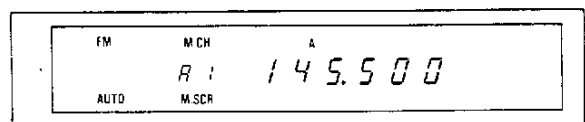

(When 145,500 MHz is stored in Memory Channel A1.)

3. Select the desired call channel number.

C1 for 2 meters, C2 for 70 cm, or C3 for 1200 MHz.

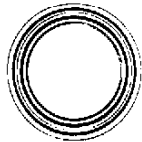

144 MHz Band

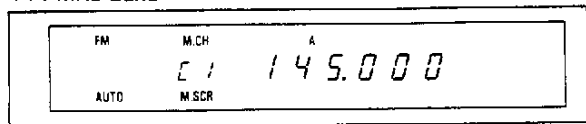

430 MHz Band

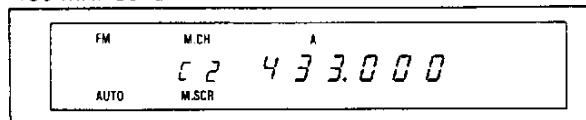

1200 MHz Band (Optional in the TS-790A/790E)

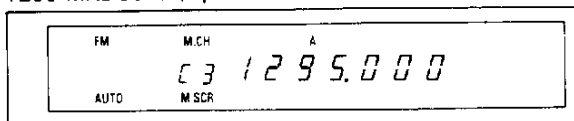

4. When the desired call memory channel is found and displayed, press the M.IN key again. The current frequency and mode will be stored, the Memory Scroll mode will be cancelled, and the TS-790A/790E will return to the operating mode and frequency that was displayed before the M.IN key was pressed initially.

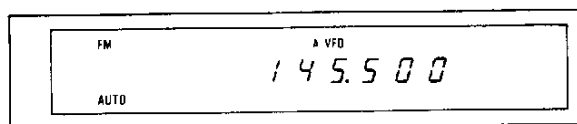

5. To confirm the CALL channel contents press the CALL key and select the Channel. The NEW CALL channel will appear.

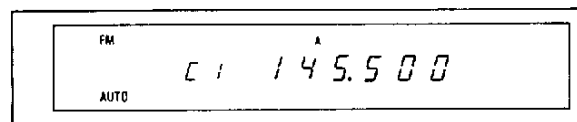
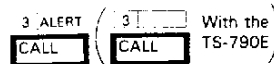

6. To return to normal VFO operations press the CALL key.

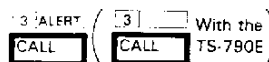

4-4-6. Memory Channel Recall

Fixed channel type recall is possible when using the VFO/M key to recall Memory Channel information. The stored frequency cannot be changed.

The following procedure shows how to recall the channel.

1. During VFO operation, press the VFO/M key to initiate Memory Channel operation. This causes the Memory Channel to return to the status (mode, and frequency) prior to the Memory Channel operation.
2. Select a Memory Channel by using the TUNING knob.
3. If you press the VFO/M key again, the original VFO operating information will be restored.

4-4-7. Memory Channel Scroll

The following procedure provides a method to check a Memory Channel Frequency without changing or losing the current receive frequency.

1. During Memory Channel operation, press the VFO/M key to change to VFO operation.
2. Press the M.IN key once to initiate Memory Scroll. The M.SCR indicator lights, and the Memory Channel Frequency is displayed. (Although the displayed frequency will change, actual reception will be at the previous frequency (that is, the frequency before the M.IN key is pressed) of the VFO.)
3. Select a Memory Channel using the TUNING knob. The frequency stored in the Memory Channel will be displayed.
4. To clear Memory Scroll operation, press the CLEAR key or the M.IN key again.

4-4-8. Transferring Memory Information to the VFO.

The following procedure transfers the contents of the Memory Channel to the VFO without erasing the contents of the memory channel.

1. In the VFO mode, press the VFO/M key to set the Memory Channel mode. This returns the Memory Channel to the status (mode, and frequency) prior to the VFO operation. To transfer the memory contents to a VFO which is not currently operating, press the A/B key before pressing the VFO/M key, in order to switch to the desired VFO.
2. Select the desired Memory Channel by using the TUNING knob.
3. Press the M ► V key. The contents of the Memory Channel will be transferred to the VFO and operation changes to the VFO mode.

If you transfer the contents of one of the Split Frequency Memory Channels to the VFO, the transceiver will automatically select the SPLIT mode.

Notes:

1. When the M ► V key is pressed, the contents of the VFO are cleared but the contents of the Memory Channel will not be cleared.
2. If nothing is stored in the selected Memory Channel, only the channel number is displayed; no transfer is carried out.

4-4-9. Transferring memory information between Memory Channels.

The following procedure transfers the contents of one Memory Channel to the other Memory Channel.

1. In the VFO mode, press the VFO/M key to select Memory Channel mode. This returns the Memory Channel to the status, (mode, and frequency) prior to the VFO operation.
2. Select the desired Memory Channel by using the TUNING knob.
3. Press the M.IN key. The M.SCR indicator will light.
4. Use the TUNING knob to select the Memory Channel that you want to transfer to the VFO.
5. When the desired Memory Channel is found and displayed, press the M.IN key again. The current frequency, mode and antenna number will be stored, the Memory Scroll mode will be cancelled.
6. If you press the VFO/M key again, the original VFO operating information will be restored.

Notes:

1. To erase a Memory Channel when a empty Memory Channel is available, use the procedure given in 4-4-9 above.
2. The various types of memory shift operations are described below.

For example, if a Split Memory Channel is shifted to a programmed scan channel, the receiving frequency of the Split Memory Channel will be the lowest operating frequency, and the transmit frequency of the Split Memory Channel will be the highest operating frequency.

Transferring memory information to the Memory Channel		Standard Memory Channel (00 to 29) Alert Channel Call Channel		Split Memory Channel (30 to 49)		Programed Scan Memory Channel	
		Transmit and receive frequency	Receive frequency	Transmit frequency	Lowest operating frequency	Highest operating frequency	
Memory Channels	Standard Memory Channel (00 to 29) Alert Channel	↑	↑	↑	↑	↑	
	Split Memory Channel (30 to 49)	Receive frequency	↑	×	↑	×	
		Transmit frequency	×	×	↑	↑	
	Programed Scan Memory Channel	Lowest operating frequency	↑	↑	×	/	
		Highest operating frequency	×	×	↑	/	

4-4-10. Memory Channel Selection

A. To select a memory channel

1. During VFO operation, press the VFO/M key to initiate Memory Channel operation.
2. Turn ON the MHz switch (the MHz indicator lights) and press the microphone UP/DOWN switch; to select the desired memory channel.
3. To return to normal VFO operations press the VFO/M key.

B. To change to an open channel.

1. During VFO operation, press the VFO/M key to initiate Memory Channel operation.
2. Press the M.IN switch (the M.SCR indicator lights) and press the microphone UP/DOWN switch; an open channel will be selected.
3. To return to normal VFO operations press the CLEAR key and press the VFO/M key.

4-4-11. Clearing a Memory Channel

To erase a specific Memory Channel:

Press and hold the CLEAR key for approximately 2 seconds or transfer data from an empty Memory Channel to the Memory Channel you wish to clear. (Please refer to Section 4-4-9 for additional information.)

4-5. SCAN

Both Memory Scan and Program Scan are possible.

Note:

The FUNCTION keys will be locked when the MAIN (SUB) VFO or memory is scanned and it will not be possible to vary operations of the SUB (MAIN) VFO.

4-5-1. Memory Scan

During memory channel operation, pressing the SCAN key will cause the radio to scan the memory channels repeatedly, skipping the channels that have no data stored.

- **Scanning the MAIN channel.**

When the MAIN frequency is the same as the SUB band frequency, the SUB display will indicate "OFF".

- **Scanning the SUB channel.**

Memorized frequencies (except the MAIN band frequency shown on the MAIN display) will be scanned.

Cautions:

1. Frequencies that have not been previously memorized will not be scanned.
2. Scan will not begin and an audible alarm will sound if you press the SCAN key when no frequency data has been previously stored.

To cancel scan press the SCAN key or press the CLEAR key.

If you press the VFO/M key, the original VFO operating information will be restored.

■ Band Scan

You may initiate scan in a specific band by pressing the appropriate key while scan is in progress.

- 1 SEL** / **OFFSET** : Press for 144 MHz band scan.
- 2 SEL** / **TONE** : Press for 430 MHz band scan.
- 3 ALERT** / **CALL** : Press for 1200 MHz band scan.
- 0** / **M.IN** : Press to cancel band scan.

4-5-2. Programmable Band-scan

1. If you press the SCAN key during VFO operation scan will begin at the current frequency and proceed upwards.
2. If you press the OFFSET key during scan, the frequency range memorized in memory channel P1 will be scanned repeatedly. Similarly, the frequency range memorized in memory channel P2 or P3 will be scanned repeatedly when the TONE key or CALL key is pressed.

- 1 SEL** / **OFFSET** : To scan in range memorized in P1.
- 2 SEL** / **TONE** : To scan in range memorized in P2.
- 3 ALERT** / **CALL** : To scan in range memorized in P3. (optional in TS-790A/790E)

3. During scan, you can change the direction of scanning with the TUNING knob or microphone UP/DOWN switch.

4. To cancel scan press the SCAN key or press the CLEAR key.

If you press the SCAN key when no data is memorized in the program memory, scan will begin from the currently displayed frequency.

How to check (possible only in MAIN channel).

Select memory channel mode, select the desired program channel with the TUNING knob, and check with the REV key.

Enter the upper and lower limits of the desired frequency range in the program memory. You can then scan within the frequency range. (See 4-4-5 C. Programmed Scan Memory Channel).

- a. If scan is initiated within the limits specified in program scan memory scan will proceed thru that range.

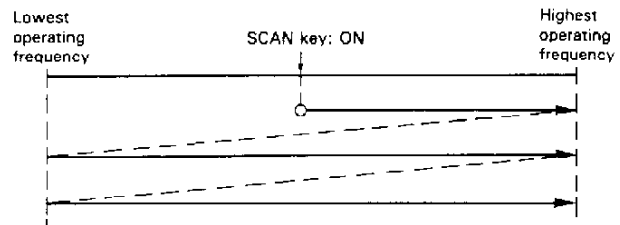

- b. If scan is initiated outside the limits specified in program scan memory scan will begin at the lowest operating frequency.

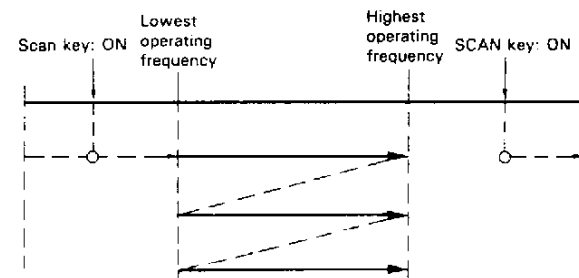

4-5-3. Memory Channel Lockout

This transceiver has a Memory Channel lockout function which allows you to temporarily skip unwanted Memory Channels during memory scan. Locking out unwanted channels will help to increase the effective scan speed.

1. Press the VFO/M key to enter the Memory Channel mode.
2. Select the Memory Channel that you want to skip using the TUNING knob.
3. Press the CLEAR key.
4. A decimal point will appear in the M.CH display to indicate that the channel will be skipped.
5. To cancel the lockout, select the desired channel and then press the CLEAR key. The decimal point will go out indicating that the channel will again be scanned.

Note: _____

Holding the CLEAR key depressed for longer than 2 seconds will clear that channel.

4-5-4. Scan Hold

Time operate scanning is selected initially (i.e., scanning stops (for about 5 seconds) when the BUSY indicator lights). You can switch to carrier-operated scanning (scanning stops when signal is received) by pressing the TO/CO key during scan.

To resume scan, rotate the TUNING knob or press the microphone UP/DOWN switch.

4-5-5. Priority Alert

When the ALERT function is active the transceiver will monitor the alert channel every 5 seconds and beep if the channel is busy (4-4-5. D. Alert channel).

1. To start the alert function, press the F key then the CALL key. (With the TS-790A).
Press the ALERT key. (With the TS-790E)
The MAIN display will read "AL".

Cautions: _____

1. The alert function does not work when SUB is selected.
 2. The frequency memorized in the call channel memory will be moved automatically to the alert channel memory if you initiate the alert function when no data has been stored in the alert channel memory.
-
2. Set the MAIN SQL control at the point where the noise just disappears.
 3. To release the function, press the F key then the CALL key again. (With the TS-790A)
Press the ALERT key again. (With the TS-790E)

If you press the F-and-CALL key (With the TS-790A), F-and-ALERT key (With the TS-790E) when the alert function is on, you will transfer to the alert channel immediately.

4-6. REPEATER OPERATION

4-6-1. TRANSMITTER OFFSETS

All amateur radio repeaters utilize a separate receiver and transmitter section. The receiver frequency may be either above or below the transmitter frequency. For most repeaters offsets are as follows:

(With the TS-790A)

Shift	Band	144 MHz	430/440 MHz	1200 MHz
+		+ 600Hz	+ 5 MHz	+ 12 MHz
-		- 600Hz	- 5 MHz	- 12 MHz

(With the TS-790E)

Shift	Band	144 MHz	430/440 MHz	1200 MHz
+		+ 600Hz	+ 1.6 MHz	+ 35 MHz
-		- 600Hz	- 1.6 MHz	- 35 MHz

4-6-2. AUTOMATIC REPEATER OFFSET

The standard ARRL and ITU Region 1 Band Plan, as far as TX offsets is concerned, has been pre-programmed into the TS-790A.

144.0 145.1 145.5 146.0 146.4 146.6 147.0 147.4 147.6 148.0

S	-	S	+	S	-	+	S	-
---	---	---	---	---	---	---	---	---

4-6-3. REVERSE FUNCTION

Some repeaters utilize a "Reverse pair", i.e. the transmit/receive frequencies are exactly the reverse of another repeater. For example repeater A uses 146.000 for a transmit frequency (OUTPUT) and 146.600 for receive (INPUT). Repeater B uses 146.000 for its receive and 146.600 for its transmit frequency. It would be inconvenient to have to reprogram the transceiver each time if you were in range of both repeaters.

The REV key allows you to reverse the transmit and receive frequencies. To use the REVERSE function press the REV key. The offset indicator (+ or -) will flash OFF and ON in the display to remind you that you are working a reverse repeater pair.

To return to normal offsets press the REV key again. In Europe press and hold the REV key to reverse the transmit and receive frequencies. This function is also useful to check the input frequency of the repeater, so that you can determine if you are within SIMPLEX communications range.

4-6-4. TONE OPERATION

Some repeaters require the use of a control signal to activate the repeater. Several versions are currently in use worldwide.

In the United States sub-audible tones are sometimes used. With the TS-790A, 38 different sub-audible tone frequency selections are possible.

The use of the optional sub-audible tone encoder/decoder (TSU-5) also allows for CTCSS (Tone Squelch) operations.

In Europe a 1750 Hz tone is used in transmit. Press and hold the TONE key to transmit the access tone, then press the PTT switch.

Since use of this tone is required in the Europe and the United Kingdom, and 1750 Hz tone encoder is included as standard equipment.

• Tone Activation (TS-790A only)

To activate the TONE function depress the TONE key. The TONE indicator will appear in the display to signify the tone has been activated. To turn the tone OFF press the TONE key again.

Tone frequency selection

1. Press the F key and then the TONE key. The current tone frequency will be displayed.
2. Rotate the TUNING knob or press the Microphone UP/DOWN switches until the desired tone frequency appears in the display.
3. To return to the normal frequency display, press the TONE key, any one of the keys, or Microphone PTT switch.

Tone Frequency

67.0 Hz	107.2 Hz	167.9 Hz
71.9 Hz	110.9 Hz	173.8 Hz
74.4 Hz	114.8 Hz	179.9 Hz
77.0 Hz	118.8 Hz	186.2 Hz
79.7 Hz	123.0 Hz	192.6 Hz
82.5 Hz	127.3 Hz	203.5 Hz
85.4 Hz	131.8 Hz	210.7 Hz
88.5 Hz	136.5 Hz	218.1 Hz
91.5 Hz	141.3 Hz	225.7 Hz
94.8 Hz	146.2 Hz	233.6 Hz
97.4 Hz	151.4 Hz	241.8 Hz
100.0 Hz	156.7 Hz	250.3 Hz
103.5 Hz	162.2 Hz	

Caution:

This key is inoperative when:

- In modes other than FM.
- SUB is selected.

4-6-5. AUTOPATCH (U.S.A. version only)

Some repeaters offer a service known as autopatch. This allows you to dial a telephone number from your transceiver and carry out a telephone conversation, much like a car telephone, or cellular telephone. This function requires the use of a DTMF (Dual Tone Multi Frequency) pad. In addition to the normal 12 keys that are found on your telephone the MC-48B microphone also provides 4 additional keys, A, B, C, and D. These keys are required by some repeater systems for various control functions. You should check with the control operator of your repeater to determine if their use is required. A chart is provided that lists the tones that are generated when you press each key.

1. To activate the DTMF pad, press and hold the PTT switch.
2. Now press the keys just as you would dial a telephone.
3. The transceiver will remain keyed for about 2 seconds after you press each number, so you can release the PTT switch without unkeying the transceiver.

Note:

Some repeaters will require a special sequence of keys to activate the Autopatch. Again you should check with the control operator of your repeater for this sequence.

Audio tones	(Hz)			
Column	1209	1336	1477	1633
Row				
697	1	2	3	A
770	4	5	6	B
852	7	8	9	C
941	*	0	#	D

Downloaded by
 Amateur Radio Directory

www.hamdirectory.info

4-7. TONE SQUELCH (CTCSS) (TS-790A only)

4-7-1. Tone Squelch Operation Initiated by the Distant Station.

Note: _____

This function requires the use of the optional TSU-5 Programmable Tone Decoder Unit.

This function allows you to remain squelched until the proper Tone Frequency is received. If you are on a busy repeater this can be quite an aid.

1. Press the CTCSS key. The CTCSS indicator will light in the Display Panel.
2. Your radio will now remain squelched until the proper code is received. You should ensure all the stations you wish to communicate with use the same Tone Frequency. Please note that the 97.4 Hz Tone does not function for decode purposes. Please see Section 4-6-4 TONE OPERATION for programming the CTCSS Tone Frequency.
3. To release the Tone Squelch function (normal noise activated squelch), press the CTCSS key again. The CTCSS indicator should go out on the Display Panel.

Note: _____

Switching the CTCSS function ON activates the Tone Frequency filter that attenuates low audio frequencies. This filtering slightly affects the quality of received audio, but does not indicate a transceiver malfunction.

4-7-2. To Open the Tone Squelch of a Distant Station

Even if the optional TSU-5 Programmable Tone Decoder Unit is not installed, your radio can open the Tone Squelch of a distant station.

1. Press the CTCSS key. The CTCSS indicator will light in the Display Panel.
2. Select the same Tone Frequency between the stations you wish to communicate. See Section 4-6-4 TONE OPERATION.
3. Press the microphone PTT switch.
4. To release the Tone Squelch function, press the CTCSS key again. The CTCSS indicator should go out on the Display Panel.

4-8. TRACE FUNCTION

This function allows you to change the frequency of both the MAIN and the SUB band simultaneously. Rotating the TUNING knob clockwise will cause the frequency of the MAIN and SUB band to increase, and rotating the knob counterclockwise will cause the frequency to decrease.

1. Select the VFO mode for both the MAIN and SUB bands.
2. Select the desired starting frequency for the MAIN and SUB bands.

Caution: _____

This function requires that you must select the same mode and frequency step for both bands for proper operation.

3. Press the F and then the SPLIT key.
4. Turn the TUNING knob clockwise to increase and counterclockwise to decrease the frequency of both bands simultaneously.
5. To release the function, press the F and then the SPLIT key again.

4-9. SATELLITE COMMUNICATIONS

Satellite communications utilize numerous frequencies and modes in a pre-assigned band plan. Transponders are used to control the contact. For example, part of the band plan of OSCAR 13 utilizes a frequency arrangement known as Mode B. In this mode, you would transmit to the satellite (uplink) in the set frequency range of 435.425 – 435.575 MHz. Your signal will be processed by the transponder and re-transmitted back to earth (downlink) in the frequency range of 145.975 – 145.825 MHz. The TS-790A is capable of allowing the uplink and downlink frequencies to track simultaneously by storing the sum of the two frequencies in memory. Memory channels 0–2 are programmed by the factory for FO-12 and OSCAR 10. The remaining memories are user programmable. To operate the TS-790A in the satellite mode, proceed as follows.

OSCAR 13	
Uplink frequency	435.425 – 435.575 MHz (LSB)
Downlink frequency	145.975 – 145.825 MHz (USB)
General beacon freq.....	145.812 MHz
Engineering beacon freq	145.985 MHz

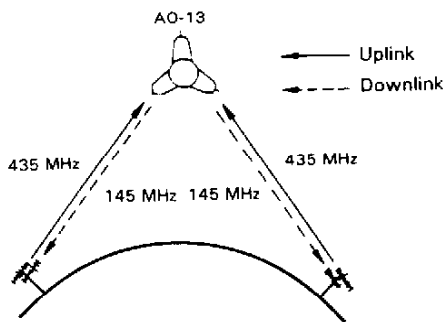

Memory CH.	Frequency	Mode
0	581.800.0	FO-12. JA Mode
1	581.004.0	A0-10. B Mode
2	1706.000.0	A0-10. L Mode

ENTERING DATA

Determine the uplink and downlink frequencies of the satellite you are tracking. Add the two frequencies together. The sum can now be placed in memory as follows:

1. Press the F key and then the SAT key.

Note:

This function is inoperative when SUB is selected.

2. Rotate the TUNING knob to select the desired satellite memory channel.
3. Press the ENT key and then enter the frequency using the numeric keypad. The frequency will automatically be stored after the seventh digit has been entered.

RECALLING DATA

The satellite memory channels can be recalled in the following manner.

1. Press the F key and then the SAT key.

Note:

This function is inoperative when SUB is selected.

2. Rotate the TUNING knob to select the desired satellite memory channel.
3. Press the SAT key to recall the initial mode setting.

OPERATING PROCEDURE

1. Recall the desired satellite memory channel as described above.
2. Select the SUB function.
3. Use the TUNING knob to select the desired downlink (receive) frequency.
4. Press the SAT key. The MAIN display will shift to the correct uplink frequency.
5. Each time you change the SUB frequency, press the SAT key twice in order to update the MAIN display. The first time the SAT key is pressed, the transceiver goes out of the satellite mode. The second time it is pressed, the transceiver goes back into the satellite mode and updates the MAIN display. An alternative method is to press and hold the SAT key when going into the satellite mode. While the key is held, the TUNING knob can be rotated and both displays will track simultaneously.

Note:

In step 2, the SUB key was pressed to allow the TUNING knob to control the downlink (receive) frequency. If the MAIN key is pressed, the TUNING knob will control the uplink (transmit) frequency.

4-10. DATA COMMUNICATIONS (PACKET, AMTOR, RTTY, SSTV, etc.)

Packet communications will require the use of a terminal unit (available from your dealer).

1. The Accessory 2 terminal has been provided for connection of Data communications devices. All necessary connections can be accomplished from the same connector.
2. When using AFSK (Audio Frequency Shift Keying) or modulating the signal with any form of audio tones you should select LSB or USB. If F2 operation is desired select the FM mode.
3. The transceiver will transmit according to the signals received on the STBY pin of the connector. These inputs are generated by the terminal unit in response to inputs from the associated terminal input device.
4. When using LSB, or USB the MIC gain control should be used to adjust the input level for an on scale ALC meter reading.
5. Various forms of data communication like AFSK, RTTY and PACKET are possible.

Cautions:

1. Do not transmit key down for an extended periods since damage to the unit might occur.
2. After continued transmission, allow the system to cool before retransmitting.

ACC2 pin assignments

Pin number	Symbol	Use
1	SAF	SUB receiver audio at a fixed level independent of AF control setting. Output voltage: 300 mV/47kΩ or more at high input level
2	ACC	Connected in parallel with ACC 3 pin jack.
3	MAF	MAIN receiver audio at a fixed level independent of AF control setting. Output voltage: 300 mV/47 kΩ or more at high input level.
4	GND	Ground of MAF. (Connect GND of MAIN audio output's shield cable).

5	MSQ	GND when MAIN squelch is open (MAIN BUSY indicator is lit). Open when MAIN squelch is closed (MAIN BUSY indicator is out). When connection is made to this terminal, you cannot send packets while squelch is open. In SSB-CW mode, reception signal will disappear and the squelch will take time to close.
6	MSM	MAIN S-meter output (parallel with device's S-meter). Reading of the internal S-meter will be incorrect if you terminate with an impedance of less than 10 kΩ.
7	SSQ	GND when SUB band squelch is open (SUB BUSY indicator is lit). Open when SUB squelch is closed (SUB BUSY indicator is out). Normally unused since MAIN channel is used for packet communication.
8	GND	Ground of SAF. (Connect GND of SUB audio output's shield cable).
9	PKS	Standby terminal exclusively for terminal units. When this terminal is used, the front panel microphone audio input will be muted automatically.
10	SSM	SUB S-meter output (analog voltage). Reading of the internal S-meter will be incorrect if you terminate with an impedance of less than 50 kΩ. Do not apply external voltage to this terminal.
11	PKD	Transmit audio input terminal (10 mV, 1 kHz) from terminal.
12	GND	Ground of PKD. (Connect GND of data signal shield cable)
13	S S	PTT terminal. Transmission begins when grounded. Use Pin 4 or 8 as chassis GND.

4-11. OPERATION WITH A PERSONAL COMPUTER (Requires optional IF-232C)

Control with a personal computer is possible with the optional IF-232C interface. For more information, refer to the manuals provided with the interface.

■ Function list

- **AUTO INFORMATION ON/OFF setting**
- **BUSY signal readout**
- **CTCSS number selection and readout**
- **CTCSS ON/OFF selection and readout**
- **DESTINATION CODE selection and readout**
- **Same function as microphone UP/DOWN switch**
- **VFO A and VFO B frequency selection and readout**
- **VFO A and VFO B MEMORY CALL setting**
- **Model No. readout for transceiver recognition**
- **Display of transceiver current condition**
- **LOCK ON/OFF setting and display**
- **AUTO LOCK TUNE ON/OFF selection and readout**
- **Memory channel setting**
- **Mode setting**
- **Memory display**
- **MUTE ON/OFF selection and readout**
- **Memory entry**
- **OFFSET setting**
- **RIT frequency clearance**
- **RIT frequency UP/DOWN**
- **RIT ON/OFF setting**
- **RX: For receive operation, TX:For transmit operation**
- **Scan ON/OFF setting**
- **S-Meter signal output**
- **SPLIT ON/OFF setting**
- **STEP ON/OFF setting**
- **Sub-tone frequency setting**
- **TONE ON/OFF setting**
- **Generation of synthesized voice**

4-12. VOICE SYNTHESIZER

(Requires the use of the optional VS-2 Voice Synthesizer)

When the VOICE switch is pressed the transceiver will audibly announce the operating frequency and offset.

Example:

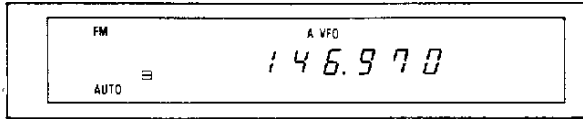

one, four, six, point, nine, seven, zero, minus

4-13. 1200 MHz IF CONNECTOR AND ACC4 CONNECTOR (Optional in the TS-790A/790E)

A 5 to 12VDC bias may be applied to the 1200 MHz IF connector, to allow a 1200 MHz IF signal to be used for transmission or reception.

1. Set the MAIN channel to the 1200 MHz band.
2. Apply 5 to 12 V to CNT terminal of the ACC4 connector.

Cautions:

1. When voltage is applied to CNT, you cannot use the front panel microphone jack and internal speaker for transmission and reception.
2. Advanced skills and knowledge will be needed for this type of operation. Be very careful to make connections exactly as shown.

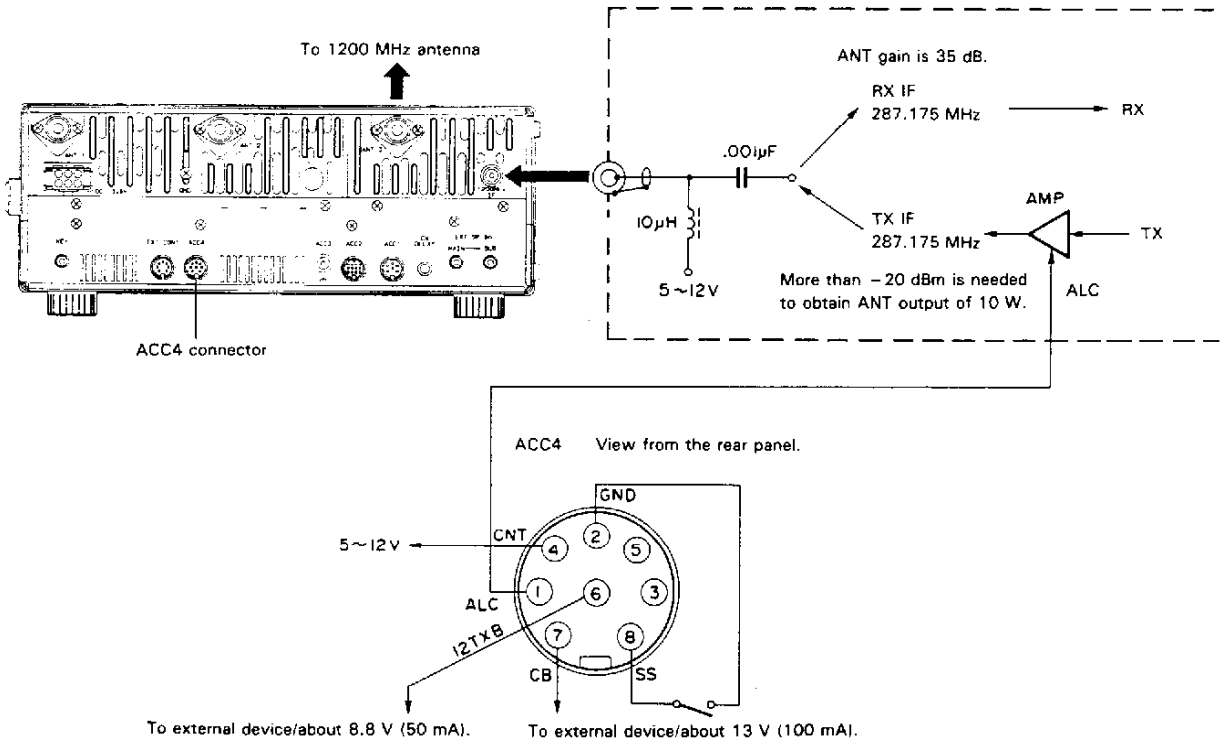

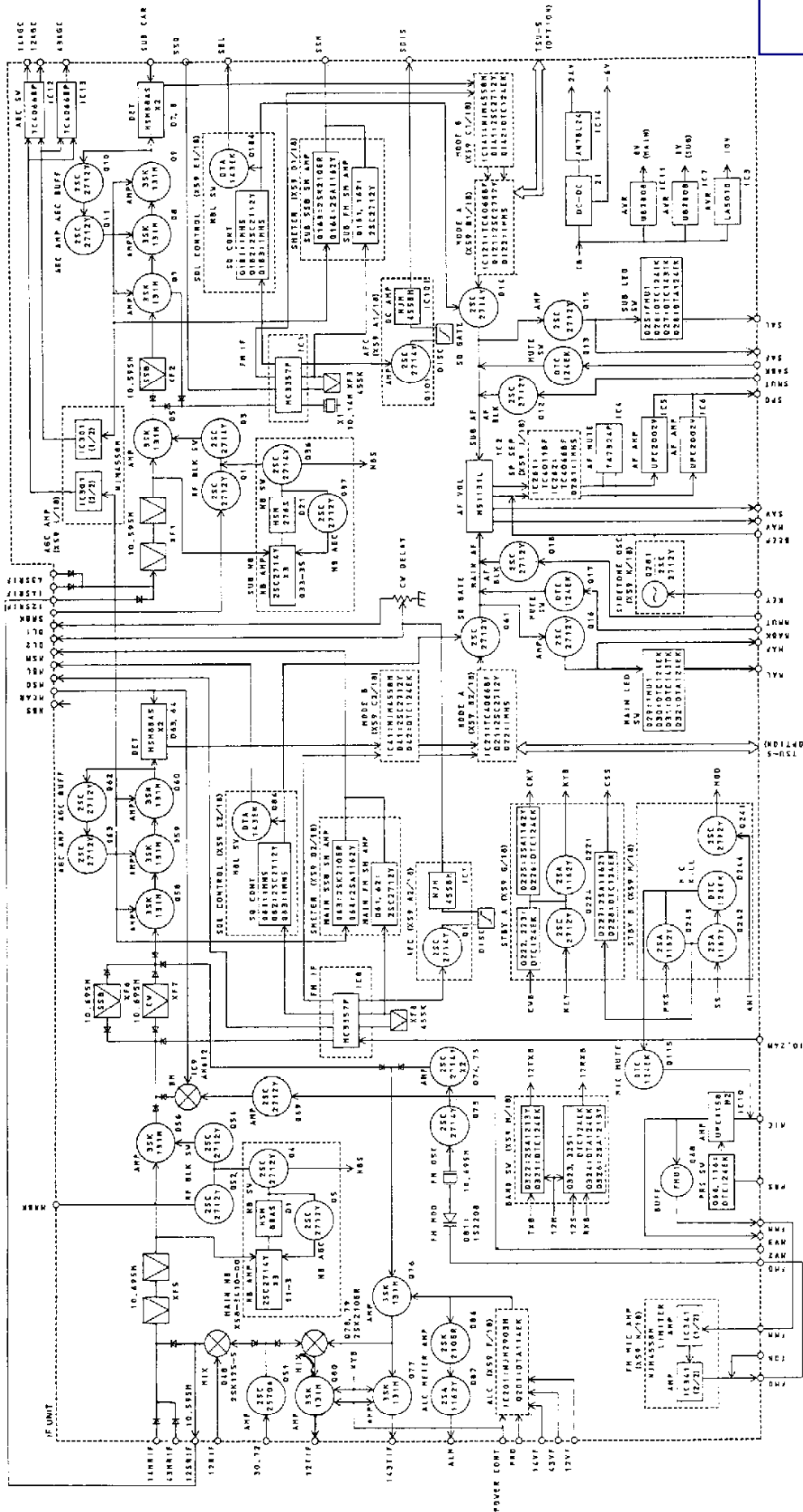

6. MAINTENANCE AND ADJUSTMENTS

6-1. GENERAL INFORMATION

Your transceiver has been factory aligned and tested to specification before shipment. Under normal circumstances the transceiver will operate in accordance with these operating instructions. All adjustable trimmers and coils in your transceiver were preset at the factory and should only be readjusted by a qualified technician with proper test equipment. Attempting service or alignment without factory authorization can void the transceiver's warranty.

When operated properly, the transceiver can give years of service without requiring realignment. The information in this section gives some general service procedures which can be accomplished without sophisticated test equipment.

6-2. SERVICE

Should it ever become necessary to return the equipment to your dealer or service center for repair, pack in its original box and packing, and include a full description of the problems involved. Also include your telephone number. You need not return accessory items unless directly related to the service problem.

You may return your radio for service to the Authorized KENWOOD Dealer from whom you purchased it. A copy of the service report will be returned with the unit. Please do not send sub-assemblies or printed circuit boards. Send the complete unit, in its original boxes and packing.

Tag all returned items with your name and call for identification. Please mention the model and serial number of your radio in any correspondence, whether phone or written. For future reference, record this information in the space provided on the back cover of this manual.

Service note: _____
Dear OM, if you desire to correspond on a technical or operational problem, please make your note short, complete, and to the point. And PLEASE make it readable.

Please list: Model and serial number.

The question or problem you are having. Please give sufficient detail to diagnose: other equipment in the station, meter readings and anything you feel might be useful in attempting diagnosis.

Caution: _____
Do not pack the equipment in crushed newspapers for shipment! Extensive damage may result, during shipping.

Notes: _____
1. Record the date of purchase, serial number and dealer from whom purchased.
2. For your own information, retain a written record of any maintenance performed on the unit.
3. When claiming warranty service, please include a photocopy of the bill of sale, or other proof of purchase showing the date of sale.

6-3. CLEANING

The knobs, front panel and cabinet of the transceiver are likely to become soiled after extended use. The knobs should be removed from the transceiver and cleaned with a neutral soap and warm water. Use a neutral soap (not harsh chemicals) and damp cloth to clean the cabinet and front panel.

6-4. IN CASE OF DIFFICULTY

The problems described in this table are failures caused in general by improper operation or connection of the transceiver, not by defective components.

Examine and check according to the following table. If the problem persists, contact an authorized agent or service station.

RECEPTION

Symptom	Probable cause	Corrective action
Nothing is displayed or wrong digits are displayed when the POWER switch is turned on.	1. Bad power cable or connections. 2. Blown power supply fuse. 3. Power supply is OFF.	1. Check cables and connections. 2. Check for the cause of the blown fuse and replace the fuse.
	The microprocessor may malfunction if the input voltage is too low.	1. Use a step-up transformer to raise the line voltage. Use a 12 V to 16 V battery. 2. Turn on the POWER switch while depressing the A = B (or A/B) key, and then release the A = B (or A/B) key.
No signal is received even when the antenna is connected or the receiving sensitivity is low.	1. SQL control fully clockwise. 2. The ATT switch is ON. 3. Microphone PTT switch is in the transmit position.	1. Turn the SQL control counter-clockwise. 2. Set the ATT switch off. 3. Set the PTT switch to the receive position.
An antenna is connected, but no signal is received and the S-meter fully deflects.	Low AC line voltage.	Use a step-up transformer to raise the line voltage. Use a 12 V to 16 V battery.
The S-meter deflects and stays at a certain position even with no signal.		
Signal is received, but no sound is heard.	MODE key position is incorrect.	Change the MODE key to the correct mode.
SSB received signal is extremely high cut or low cut.	IF SHIFT control is wrong adjusted.	Set the control to the center (click position).
Frequency is not changed by pressing the UP/DOWN switches, turning the TUNING knob.	F. LOCK key is ON.	Set F. LOCK key to OFF.
Memory scan fails.	Nothing is stored in memory.	Store the frequency.
Display goes out with VFO/M ON.	When nothing is stored in the memory channel, a channel is displayed and blanked with only the decimal point displayed.	
SUB indicator remains OFF, and the desired frequency can not be selected.	MAIN and SUB bands are set to the same frequency.	Push the SUB key to select another band.

TRANSMIT

Symptom	Probable cause	Corrective action
Output	1. Microphone jack is not plugged in. 2. Poor antenna connection.	1. Plug jack in. 2. Connect antenna securely.
In CW, pressing the key does not cause transmission.	1. Key jack is not plugged in. 2. Poor key contact.	1. Plug jack in. 2. Clean contact.
In USB, LSB, CW, AM, or FM the called station does not answer.	RIT causes send and receive frequency mismatch.	Press RIT switch to exit RIT mode.

6-5. ORDERING SPARE PARTS

When ordering replacement or spare parts for your equipment, be sure to specify the following: Model and serial number of your transceiver. Schematic number of the part. Printed circuit board number on

which the part is located, part number and name, if known, and quantity desired. Part numbers for most replacement parts is contained in the service manual (available as an option from your dealer).

6-6. ADJUSTMENTS

6-6-1. Cover Removal

Removing the covers

Remove the top cover, and the bottom covers from radio.

Cautions:

1. Before removing the cover, turn the DC power supply's power switch OFF and disconnect the power cable.
2. Do not pinch wiring when opening or closing cases.

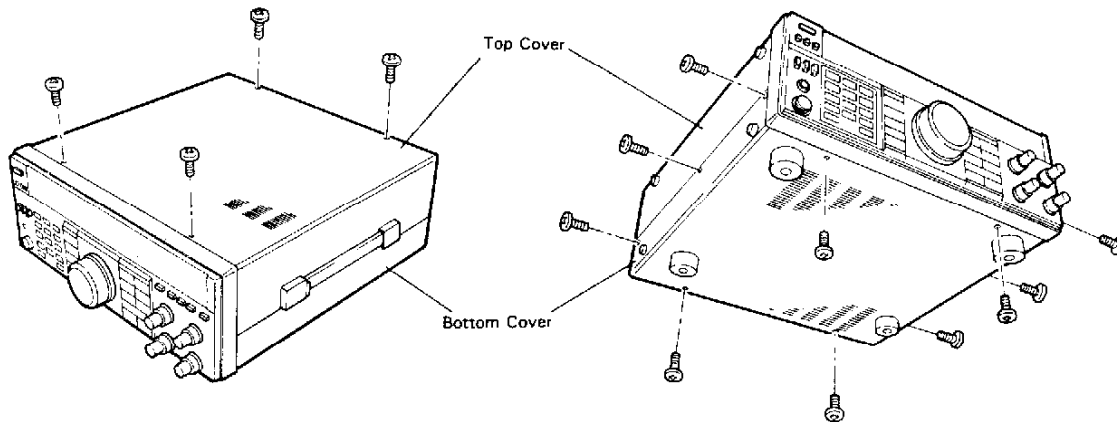

6-6-2. SUB audio mute control

This adjustment should be made while listening to the SUB channel. Turn the SUB MUTE switch on and off and adjust VR3 for the desired audio level.

6-6-3. MAIN audio mute control

This adjustment should be made while listening to the MAIN channel. Turn the MAIN MUTE switch on and off and adjust VR4 for the desired audio level.

6-6-4. Sidetone Level

Turn VR35 while holding down the key in the CW mode for the desired tone level.

6-6-5. Beep Tone Level

Turn VR5 to the desired tone volume.

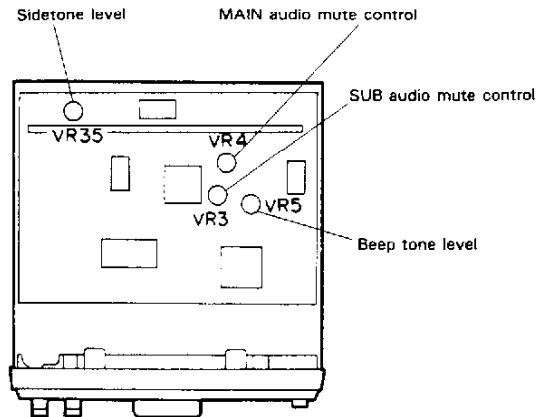

7. OPTIONAL ACCESSORIES

Be sure to unplug the DC power cable before starting work.

7-1. VS-2 VOICE SYNTHESIZER INSTALLATION

1. Remove the bottom cover of the transceiver. Refer to Section 6-6-1.
2. Plug in the 8 pin connector that is located near the front panel as shown.
3. Fasten the VS-2 with two binding screws (M2.6 x 4) provided with the unit.

Caution: _____
 Keep the pan-head screw, binding screw, and pad provided with the VS-2 for later use. They are not needed now.

4. Replace the bottom cover.

Note: _____
 Avoid catching your fingers and wiring harness when closing.

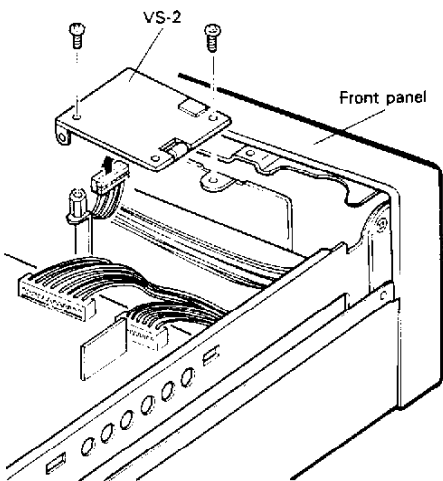

7-2. TSU-5 PROGRAMMABLE TONE DECODER UNIT INSTALLATION (TS-790A only)

1. Remove the bottom cover of the transceiver. Refer to Section 6-6-1.
2. 1) MAIN installation
 - Remove the protective sheet from the pad and glue it to the TSU-5.

Caution: _____
 Attach as shown in the accompanying illustration.

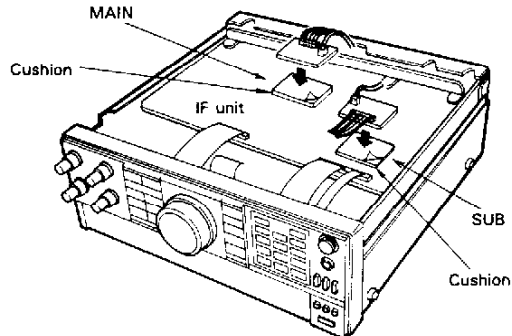

- Remove the two-pin jumper plug from the IF unit's connector (CN40).
- Plug the two-pin connector (with leads) from the TSU-5 onto CN40, and the seven-pin connector (with leads) from the IF unit onto the TSU-5.

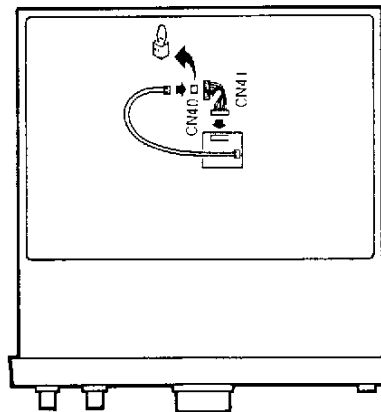

Caution: _____
 Keep the two screws provided with the TSU-5 for later use. They are not needed now.

2) SUB installation (right bottom)

- Remove the two-pin connector (with leads) from the TSU-5.

Caution:

Keep the two-pin connector (with leads) for later use. It is not needed now.

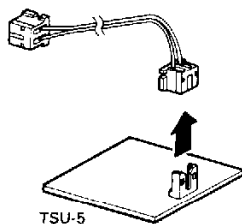

- Remove the protective sheet from the pad and attach it to the TSU-5.

Caution:

Attach as shown in the accompanying illustration.

- Remove the two-pin jumper plug from CN9.
- Plug the seven-pin connector (with leads) from the IF unit onto the TSU-5. Connect the TSU-5 to CN9 using the two-lead cable provided.

Caution:

Keep the two screws provided with the TSU-5 for later use. They are not needed now.

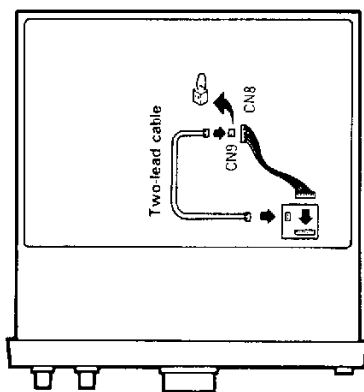

3. Replace the bottom cover.

Note:

Avoid catching your fingers and wiring harness when closing.

7-3. UT-10 1200MHz UNIT INSTALLATION

Note:

The UT-10 is not available in some areas.

1. Remove the top and bottom covers of the transceiver. Refer to Section 6-6-1.
2. Remove five bushings from the top cover using diagonal cutters (Refer to figure A).

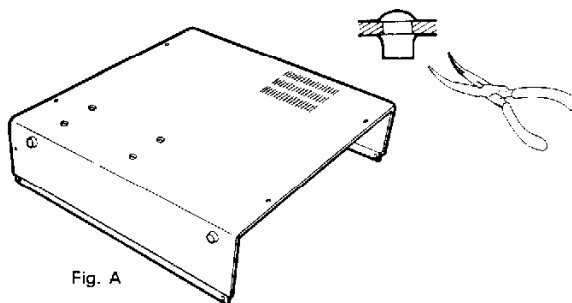

3. Remove the sub panel from the rear of the chassis as shown in Fig. B.

Caution:

Keep the two screws removed for later use. They are not needed now.

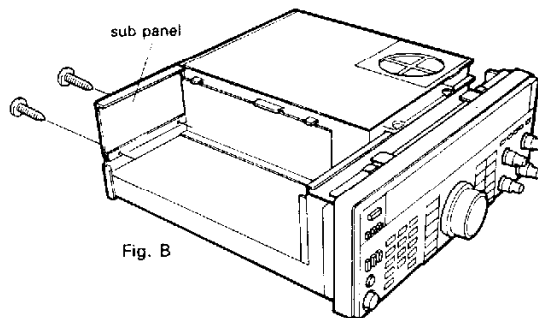

4. Attach the 18-pin connector and the 11-pin connector from the UT-10 as shown in Fig. C.

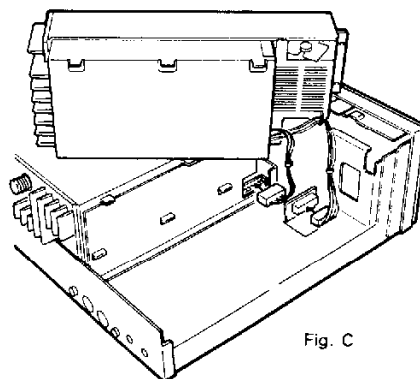

Downloaded by
Amateur Radio Directory

www.hamdirectory.info

5. Place the UT-10 as shown in Fig. D. Fasten it to the chassis with three screws (A) and nine self tapping screws (M3 × 8) as shown in Fig. D.

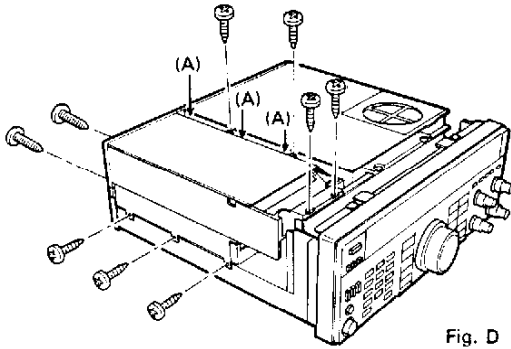

Fig. D

6. Replace the top and bottom covers. Use five pan-head screws (B) provided with the UT-10.

Note:

The top cover is secured to the top of the UT-10 with 5 additional 5 pan-head screws. See figure E.

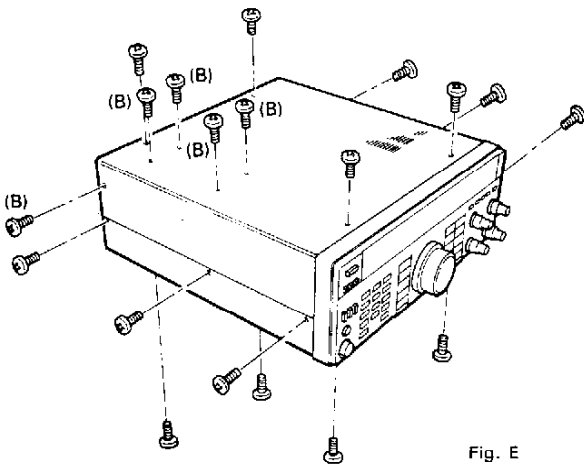
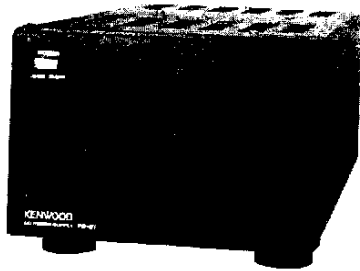

Fig. E

7-4. OTHER ACCESSORIES

■ PS-31 DC POWER SUPPLY

Designed to match the TS-790A/790E.



PS-31

■ MC-85 MICROPHONE (8-pin)

The MC-85 is a unidirectional high-class electret condenser microphone provided with the output selective switch, audio level compensation circuit, low cut filter, level meter, PTT and LOCK switches. An 8-pin cable is provided, with optional cables, up to three outputs are possible.

■ MC-80 MICROPHONE (8-pin)

The MC-80 is an omnidirectional electret condenser microphone provided with UP/DOWN switches, volume adjustment for output level, PTT and LOCK switches, built-in pre-amplifier.

■ MC-60A MICROPHONE (8-pin)

The zinc die-cast base provides high stability, and the MC-60A is complete with PTT and LOCK switches, UP/DOWN switches, and impedance selector switch and a built-in pre-amplifier.

■ MC-43S UP/DOWN HAND MICROPHONE

The MC-43S is handy dynamic microphone with PTT switch and UP/DOWN switches.

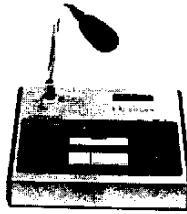

MC-85



MC-60A

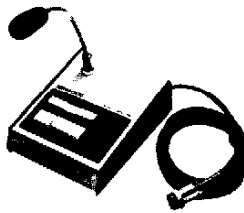

MC-80



MC-43S

8. REFERENCE

■ MC-48B AUTOPATCH UP/DOWN HAND MICROPHONE (8-pin)

The MC-48B is 16-key autopatch UP/DOWN microphones with PTT switch. Encodes 16 autopatch tones. UP/DOWN switches provide step frequency change, or initiate band scan in the appropriate direction, if held depressed momentarily.

■ PG-2X DC POWER CABLE

■ SP-31 EXTERNAL SPEAKER

Designed to match the TS-790A/790E.

■ TSU-5 PROGRAMMABLE TONE DECODER UNIT

■ IF-232C INTERFACE

The IF-232C Interface is the adapter for connection between the RS-232C terminal of a personal computer and the interface terminal of the TS-790A/790E.



MC-48B

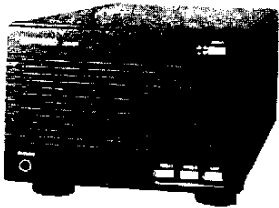

SP-31

■ ANTENNA

Fixed Station

Various types of fixed station antennas are commercially available. Select your antenna according to available space and intended application. Transceiver performance depends largely on the type of antenna used. For fixed station operation there are ground plane antennas (omnidirectional) and Yagi antennas (unidirectional). The Yagi antenna is suitable for DX (Long distance) operation or communication with a specific party.

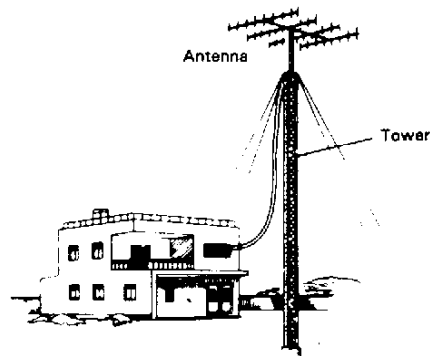
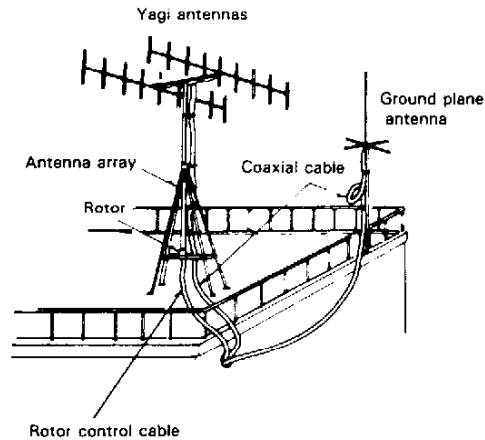

KENWOOD

Downloaded by
Amateur Radio Directory

www.hamdirectory.info
